

Installer manual

NIBE F470

1x230V

Exhaust air heat pump

IHB EN 1751-1
431683

Quick guide

Navigation

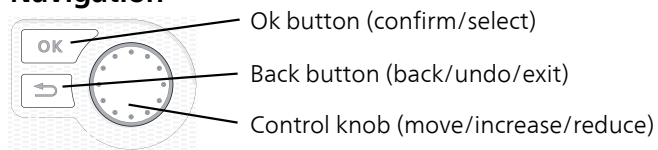

A detailed explanation of the button functions can be found on page 38.

How to scroll through menus and make different settings is described on page 40.

Set the indoor climate

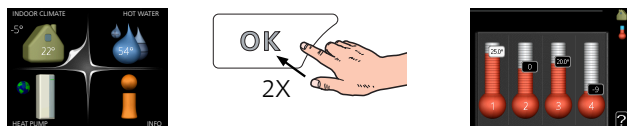

The mode for setting the indoor temperature is accessed by pressing the OK button twice, when in the start mode in the main menu.

Increase hot water volume



To temporarily increase the amount of hot water, first turn the control knob to mark menu 2 (water droplet) and then press the OK button twice.

Table of Contents

1 Important information	4	7 Control - Introduction	38
Safety information	4	Display unit	38
General	9	Menu system	39
2 Delivery and handling	12	8 Control - Menus	42
Transport	12	Menu 1 - INDOOR CLIMATE	42
Assembly	12	Menu 2 - HOT WATER	42
Supplied components	13	Menu 3 - INFO	42
Removing the covers	13	Menu 4 - HEAT PUMP	43
Removing parts of the insulation	13	Menu 5 - SERVICE	44
3 The heat pump design	14	9 Service	48
Pipe connections	15	Maintenance	48
HVAC components	15	Service actions	49
Sensors etc.	15	10 Disturbances in comfort	53
Electrical components	15	Info-menu	53
Cooling components	15	Manage alarm	53
Ventilation	15	Troubleshooting	53
Miscellaneous	15	11 Accessories	55
4 Pipe and ventilation connections	16	12 Technical data	56
General pipe connections	16	Dimensions and setting-out coordinates	56
Dimensions and pipe connections	18	Technical specifications	57
Symbol key	19	Energy labelling	59
Cold and hot water	19	Electrical circuit diagram	61
Heating medium side	19	Item register	67
Supply air battery	20		
Installation alternative	20		
General ventilation connection	21		
Ventilation flow	21		
Adjusting ventilation	21		
Dimension and ventilation connections	21		
5 Electrical connections	22		
General	22		
Connections	24		
Settings	26		
Optional connections	27		
Connecting accessories	29		
6 Commissioning and adjusting	30		
Preparations	30		
Filling and venting	30		
Start-up and inspection	31		
Basic values for the curve setting	37		

1 Important information

Safety information

This manual describes installation and service procedures for implementation by specialists.

The manual must be left with the customer.

This appliance can be used by children aged from 8 years and above and persons with reduced physical, sensory or mental capabilities or lack of experience and knowledge if they have been given supervision or instruction concerning use of the appliance in a safe way and understand the hazards involved. Children shall not play with the appliance. Cleaning and user maintenance shall not be made by children without supervision.

Rights to make any design or technical modifications are reserved.

©NIBE 2017.

Symbols



WARNING!

This symbol indicates serious danger to person or machine.



NOTE

This symbol indicates danger to person or machine.



Caution

This symbol indicates important information about what you should observe when maintaining your installation.



TIP

This symbol indicates tips on how to facilitate using the product.

Marking

CE The CE mark is obligatory for most products sold in the EU, regardless of where they are made.

IP21 Classification of enclosure of electro-technical equipment.



Fire hazard!



Read the User Manual.



Read the Installer Manual.

Handling

The heat pump contains highly flammable refrigerant. Special care should be exercised during handling, installation, service, cleaning and scrapping to avoid damage to the refrigerant system, and thereby reduce the risk of leakage.



NOTE

Work on the refrigerant system must be carried out by authorised personnel, in accordance with the relevant legislation on refrigerants and supplemented by the additional requirements for flammable gas; for example, product knowledge as well as service instructions for gas systems with flammable gases.

Safety precautions



WARNING!

Do not use agents to speed up the defrosting process or for cleaning, other than those recommended by the manufacturer.

The apparatus must be stored in a room with no continuous ignition sources (e.g. naked flame, an active gas installation or an active electric heater).

Must not be punctured or burned.

Be aware that the refrigerant may be odourless

General

Pipe installation should be kept to a minimum.

Area checks

Before work is started on systems that contains combustible refrigerants, safety checks must be performed to ensure that the ignition risk is kept to a minimum.

Working method

The work must be carried out in a controlled way to minimise the risk of contact with combustible gas or liquid during the work.

General for the working range

All maintenance staff and those who work in close proximity to the product must be instructed which type of work is to be carried out. Avoid carrying out work in enclosed spaces. The area surrounding the worksite must be cordoned off. Ensure that the area is made safe by removing combustible material.

Check for the presence of refrigerant

Check whether there is refrigerant in the area using a suitable refrigerant detector prior to and during work, to notify the service technician whether there is a possible flammable atmosphere or not. Ensure that the refrigerant detector is suitable for combustible refrigerant, i.e. does not generate sparks or cause ignition in any other way.

Presence of fire extinguishers

If hot work is carried out on the heat pump, a powder or carbon dioxide fire extinguisher must be to hand.

Absence of ignition sources

Those who carry out work with refrigerant system connections, including exposing pipes that contain or have contained combustible refrigerant, may not use potential ignition sources in such a way that that can lead to risks of fire or explosions.

All potential ignition sources, including cigarette smoking, should be kept at a safe distance from the service work area where combustible refrigerant can leak out. Before carrying out work, the area surrounding the equipment must be checked to ensure that there are no ignition risks. "No smoking" signs must be displayed.

Ventilated area

Ensure that the work is carried out outdoors or that the work area is ventilated before the system is opened and before any hot work is carried out. The area must be ventilated whilst the work is being carried out. There must be ventilation around any refrigerant that comes out, which should be routed outdoors.

Checking cooling equipment

If electrical components are replaced, the replacement parts must be fit for purpose and have the correct technical specifications. Always follow the manufacturer's guidelines regarding maintenance and servicing. Contact the manufacturer's technical department in the event of any doubts.

The following checks must be carried out for installations that use combustible refrigerants.

- The filling quantity is appropriate for the size of the space where the parts that contain refrigerant are installed.
- Ventilation equipment and outlet work correctly and without obstructions.
- If an indirect refrigerant circuit is used, check whether the secondary circuit contains refrigerant.
- All markings of equipment are visible and clear. Markings, signs and similar that are not clear must be replaced.

- Refrigerant pipes and components are positioned in such a way that it is not likely that they be subjected to substances that can corrode components containing refrigerant, if these components are not made of material that is resistant against corrosion, or not appropriately protected against such corrosion.

Checking electrical equipment

Repair and maintenance of electrical components must include initial safety checks and procedures for component inspection. In the event of a fault, which can cause a safety risk, do not supply any power to the circuit until the fault has been rectified. If the fault cannot be rectified immediately, and operation must continue, an adequate temporary solution must be implemented. This must be reported to the equipment owner, so that all parties have been informed.

The following checks must be carried out at the initial safety checks.

- That the capacitors are discharged. Discharging must be done safely, to prevent the risk of sparking.
- That no powered electrical components or live cables are exposed when filling or collecting refrigerant or when the system is flushed.
- That the system is continually earthed.

Repairing sealed components

When repairing sealed components, all electrical supply must be disconnected from the equipment that is being repaired before any sealed covers or similar are removed. If it is absolutely necessary to have an electricity supply to the equipment during the service, continuously activated leak tracing must be performed at the most critical points in order to warn of any dangerous situations.

Pay particular attention to the following so that the sheath is not changed in a way that affects the protection level when working with electrical components. This means damage to cables, unnecessary amounts of connections, terminals that do not follow the original specifications, damaged gaskets, incorrect grommets etc.

Ensure that the apparatus is secured properly.

Check that seals or sealing materials have not deteriorated to a degree that they can no longer prevent combustible gases from entering. Replacement parts must meet the manufacturer's specifications.



NOTE

Use of silicone seals can hamper the efficiency of certain types of leak-tracing equipment. Components with built in safety do not need to be isolated before starting work.

Wiring

Check that cabling will not be subject to wear, corrosion, excessive pressure, vibration, sharp edges or any other adverse environmental effects. The check shall also take into account the effects of aging or continual vibration from sources such as compressors or fans.

Leak testing

The following leak detection methods are deemed acceptable for systems containing flammable refrigerants.

Electronic leak tracers must be used to detect combustible refrigerant; but the leak tracer may not be sufficiently sensitive or may need to be recalibrated (the leak tracing equipment must be calibrated in an area completely free from refrigerant). The leak tracer must not be a potential source of ignition and must be suitable for the

relevant refrigerant. The leak tracing equipment must be set and calibrated for the relevant refrigerant, to ensure that the gas concentration is a maximum of 25% of the lowest combustible concentration (Lower Flammability Limit, LFL) of the relevant refrigerant.

Leak detection fluids are suitable for use with most refrigerants but the use of detergents containing chlorine shall be avoided as the chlorine may react with the refrigerant and corrode the copper pipe-work.

If a leak is suspected, all naked flames shall be removed/extinguished.

If a leakage of refrigerant is found which requires brazing, all of the refrigerant shall be recovered from the system, or isolated (by means of shut off valves) in a part of the system remote from the leak. Oxygen free nitrogen (OFN) shall then be purged through the system both before and during the brazing process.

Removal and draining

When a cooling circuit is opened for repairs – or for another reason – work must be carried out in a conventional manner. Due to the risk of fire it is important that best practice is applied. Follow the procedure below.

1. Drain the refrigerant.
2. Flush the circuit with inert gas.
3. Drain the circuit.
4. Flush again with inert gas.
5. Open the circuit by cutting or burning.

Collect the refrigerant in the intended container. Flush the system with oxygen-free nitrogen to make the device safe. This process may need to be repeated several times. Compressed air and oxygen may not be used.

Flush the system by breaking the vacuum with oxygen-free nitrogen, and filling the system to working pressure, relieving the pressure to atmospheric pressure and finally pumping to vacuum. Repeat the process until no refrigerant remains in the system. After the final filling of oxygen-free nitrogen, relieve the pressure in the system to atmospheric pressure, so that work can be carried out. This type of flushing must be carried out if hot work is to be performed on the pipe system.

Ensure that the vacuum pump's outlet is not near to ignition sources and that there is satisfactory ventilation by the outlet.

Filling

In addition to the conventional filling procedures, the following actions must be taken.

- Ensure that different refrigerants are not mixed when filling equipment is used. Hoses and lines must be as short as possible to minimise the enclosed refrigerant volume.
- Containers must be stored upright.
- Ensure that the cooling system is grounded before the system is filled with refrigerant.
- Mark the system once filling is complete (if not already marked).
- Take extra care not to overfill the cooling system.

Before refilling the system, pressure test it with oxygen-free nitrogen. Leak test the system after filling but before using the system. Perform an additional leak test before leaving the installation.

Decommissioning

Before performing this procedure, the technician must be familiar with the equipment and all its component parts.

Good practice prescribes that all refrigerant is collected safely. Before the work is carried out, samples of oil and refrigerant must be taken, if analyses are required before collected refrigerant can be reused. There must be a power supply when this task is started.

1. Familiarise yourself with the equipment and its use.
2. Isolate the system electrically.
3. Before starting the procedure, ensure that:
 - necessary equipment for mechanical handling of the refrigerant container is available
 - all necessary personal safety equipment is available and used correctly
 - the collection process is continuously supervised by an authorised person
 - the collection equipment and containers meet appropriate standards.
4. Pump the refrigerant system to vacuum, if possible.
5. If it is not possible to pump to vacuum, manufacture a branch, so that the refrigerant can be retrieved from different parts of the system.
6. Check that the refrigerant container is on the scales before starting to collect.
7. Start the collection device and collect according to the manufacturer's instructions.
8. Do not overfill the containers (max. 80 % (volume) liquid content).
9. Do not exceed the containers' maximum permitted working pressure – not even temporarily.
10. When the containers have been filled correctly and the process is complete, close all shut-off valves in the equip-

ment and remove and containers and equipment from the installation immediately.

11. The collected refrigerant must not be filled in any other system before being cleaned and checked.

Marking

The equipment must be marked stating that it has been taken out of operation and drained of refrigerant. The marking must be dated and signed. Check that the equipment is marked indicating that it contains combustible refrigerant.

Collection

Best practice prescribes that all refrigerant is collected safely when the refrigerant is drained from a system, either for servicing or for decommissioning.

The refrigerant must only be collected in suitable refrigerant containers. Ensure that the required number of containers, that can hold the entire volume of the system, are available. All containers that are to be used must be intended for the collection of the refrigerant and marked for this refrigerant (especially designed for the collection of refrigerant). The containers must have the correctly functioning relief valves and shut-off valves. Empty collection containers must be drained and, if possible, chilled before collection.

The collection equipment must function correctly and instructions for the equipment must be to hand. The equipment must be suitable for the collection of combustible refrigerant.

Fully functioning and calibrated scales must also be to hand.

Hoses must be in good condition and be equipped with leak proof quick-couplings. Before using the collecting machine, check that it works correctly and has been well

maintained, and that corresponding electrical components are sealed, to prevent ignition if any refrigerant should come out. Contact the manufacturer in the event of any doubts.

Return the collected refrigerant to the refrigerant supplier in the correct collection container and with the relevant Waste Transfer Note. Do not mix refrigerants in collection devices or containers.

If compressors/compressor oil are/is to be removed ensure that the affected device is drained to an acceptable level to ensure that no combustible refrigerant remains in the lubricant. Compressors must be drained before being returned to the supplier. Only electrical heating of the compressor housing may be used to quicken draining. Drain oil from the system in a safe manner.

Miscellaneous

Maximum amount of refrigerant: See Technical specifications.

- Everyone who works with or opens a refrigerant circuit must have a current, valid certificate from an accredited industry issuing body, which states that, according to the industry's recognised assessment standard, they have the authority to safely handle refrigerants.
- Servicing must only be performed according to the equipment manufacturer's recommendations.

Maintenance and repairs that require the assistance of another trained person must be carried out under the supervision of person with the authority to handle combustible refrigerants.

Maintenance and repair that requires the skill of another person must be carried out under the supervision of someone with the above expertise.

General

Serial number

The serial number can be found at the bottom right of the front cover and in the info menu (menu 3.1).

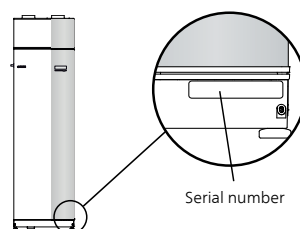

Caution

You need the product's (14 digit) serial number for servicing and support.

Recovery



Leave the disposal of the packaging to the installer who installed the product or to special waste stations.

Do not dispose of used products with normal household waste. It must be disposed of at a special waste station or dealer who provides this type of service.

Improper disposal of the product by the user results in administrative penalties in accordance with current legislation.

Country specific information

United Kingdom

This installation is subject to building regulation approval, notify the local Authority of intention to install.

Use only manufacturer's recommended replacement parts.



Benchmark places responsibilities on both manufacturers and installers. The purpose is to ensure that customers are provided with the correct equipment for their needs, that it is installed, commissioned and serviced in accordance with the manufacturer's instructions by competent persons and that it meets the requirements of the appropriate Building Regulations. The Benchmark Checklist can be used to demonstrate compliance with Building Regulations and should be provided to the customer for future reference.

Installers are required to carry out the installation, commissioning and servicing work in accordance with the Benchmark Code of practice which is available from the Heating and Hotwater Industry Council who manage and promote the Scheme. Visit www.centralheating.co.uk for information.

Warranty and insurance information

Thank you for installing a new NIBE heat pump in your home.

NIBE heat pumps are manufactured in Sweden to the very highest standard so we are pleased to offer our customers a comprehensive guarantee.

The product is guaranteed for 24 months for parts and labour from the date of installation or 33 months from the date of manufacture, whichever is the shorter.

The NIBE guarantee is based on the unit being installed and commissioned by a NIBE accredited installer, serviced every year and the Benchmark documents completed. Where this condition is not met, any chargeable spare parts or components issued within the applicable guarantee period still benefit from a 12 month warranty from the date of issue by the manufacturer.

We recommend the installer completes and returns as soon as possible, your guarantee registration card or completes the guarantee form on the NIBE website www.nibe.co.uk.

Electrical Supply

The heat pump must be permanently connected to a 230V ac 50Hz supply.

All system components shall be of an approved type and all wiring to current I.E.E wiring regulations.

External wiring must be correctly earthed, polarised and in accordance with the relevant standards: Currently this is BS 7671.

Domestic Hot Water

All domestic hot water circuits, connections and fittings must be in accordance with the relevant standards and water supply regulations. It should also be in accordance with the relevant requirements of the Local Authority and the Building Regulations relevant to the location of installation.

BS 8558:2015 Services supplying water for domestic use within buildings and their cartilages.

Water Supply (Water Fitting) Regulations 1999 or The Water Bylaws 2000 (Scotland).

Heating System

The installation of the heat pump should follow best practice as covered in the following:

BS 5449 Forced circulation hot water central heating systems for domestic premises.

BS 15450 Heating systems in buildings – Design of heat pump heating systems.

Ventilation System

Any ventilation system should be designed and installed in accordance with Building Regulations, England & Wales Approved Document F1 and Scotland Technical Standard Section 3.14 Ventilation. Only this will ensure hygienic room air and prevent any dampness to the building structure.

To be able to ensure a high degree of efficiency and an extremely comfortable living environment, we recommend that the installation of any ventilation system should be planned and this plan be strictly followed by the ventilation engineer.

We recommend that the exhaust and supply air is extracted and supplied via metal spiral seam pipes with fitting seals approved to sealing class D, or suitable equivalent UPVC plastic duct work and sealed with acrylic duct sealant. The exhaust air is extracted from the bathroom, toilet, kitchen and utility room. This will also apply to duct work carrying fresh air from the outside that is preheated in the heat pump and supplied the living quarters. Factors such as street noise, exhaust fumes, wind, general noise, cold and pollen can be taken into account choosing the right outside air vent. This ensures a controlled ventilation system with heat recovery and offers a high degree of comfort.

The discharge air duct work to outside must be insulated to ensure condensation does not form in the duct work.

Inspection of the installation

Current regulations require the heating installation to be inspected before it is commissioned. The inspection must be carried out by a suitably qualified person. In addition, fill in the page for the installation data in the User Manual.

✓	Description	Notes	Signature	Date
	Ventilation (page 21)			
	Setting ventilation flow exhaust air			
	Setting ventilation flow supply air			
	Connecting ground cables			
	Heating medium (page 19)			
	System flushed			
	System vented			
	Safety valve			
	Circulation pump setting			
	Setting heating medium flow			
	Pressure in the climate system			
	Setting trim valve, number of turns from closed position			
	Expansion vessel			
	T&P valve			
	Tundish			
	Electricity (page 22)			
	Connections			
	Main voltage			
	Phase voltage			
	Fuses heat pump			
	Fuses property			
	Outside sensor			
	Room sensor			
	Safety breaker			
	Earth circuit-breaker			
	Miscellaneous			
	Benchmark checklist			

2 Delivery and handling

Transport

F470 should be transported and stored vertically in a dry place. The F470 may, however, be carefully laid on its back when being moved into a building.

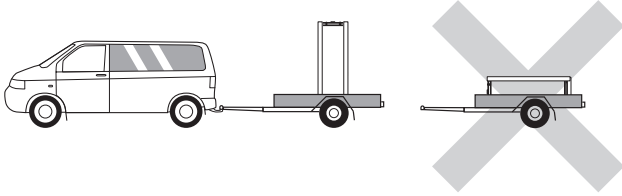

Assembly

- Position F470 on a fixed foundation that can take the weight of the heat pump. Use the product's adjustable feet to obtain a horizontal and stable set-up.

Because water comes from F470, the floor coating is important. A waterproof floor or floor membrane is recommended.

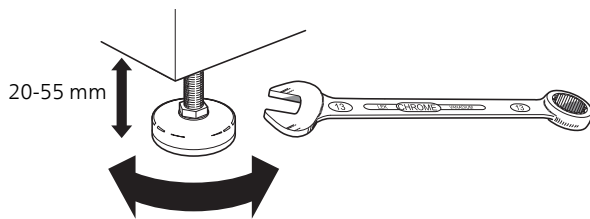

- Install with its back to an outside wall, ideally in a room where noise does not matter, in order to eliminate noise problems. If this is not possible, avoid placing it against a wall behind a bedroom or other room where noise may be a problem.
- Wherever the unit is located, walls to sound sensitive rooms should be fitted with sound insulation.
- Route pipes so they are not fixed to an internal wall that backs on to a bedroom or living room.
- The heat pump's installation area should always have a temperature of at least 10 °C and max 30 °C.

Installation area

Leave a free space of 800 mm in front of the product. Leave free space between F470 and wall/other machinery/fittings/cables/pipes etc. It is recommended that a space of at least 10 mm is left to reduce the risk of noise and of any vibrations being propagated.

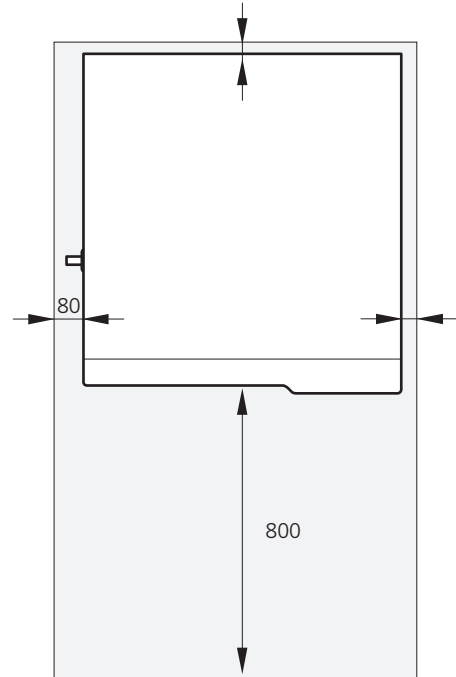

NOTE

Ensure that there is sufficient space (300 mm) above the heat pump for installing ventilation hoses.

Supplied components

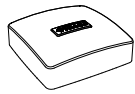

Outside sensor

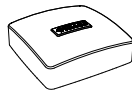

Room sensor



Earth cabling (4 pcs)

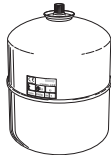

Expansion vessel with holder
(supplied separately)



2 x tundish

Location

The kit of supplied items is placed on top of the product.

Removing the covers

Front cover

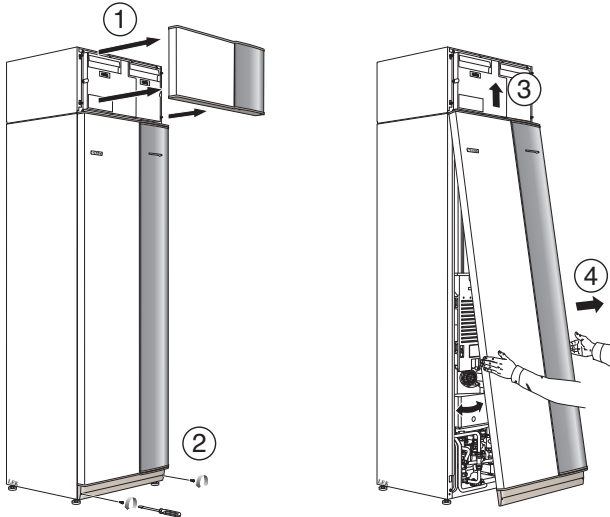

1. Remove the upper panel by pulling it straight out.
2. Remove the screws from the lower edge of the front panel.
3. Lift the panel out at the bottom edge and up.
4. Pull the panel towards yourself.

Side covers

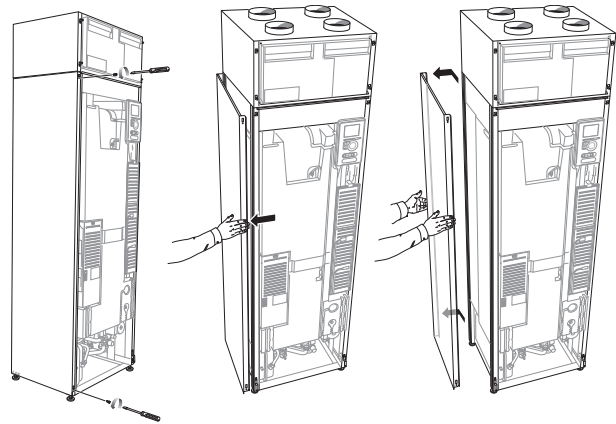

The side covers can be removed to facilitate the installation.

1. Remove the screws from the upper and lower edges.
2. Twist the cover slightly outward.
3. Move the hatch backwards and slightly to the side.
4. Pull the cover to one side.
5. Pull the hatch forwards.

Removing parts of the insulation

Parts of the insulation can be removed to facilitate the installation.

Grip the handle and pull straight out as illustrated.

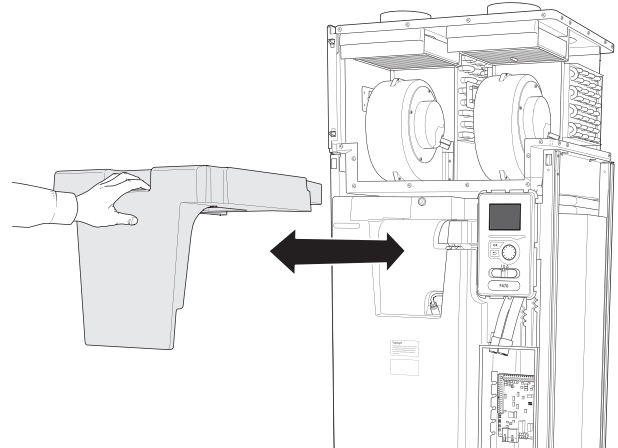

3 The heat pump design

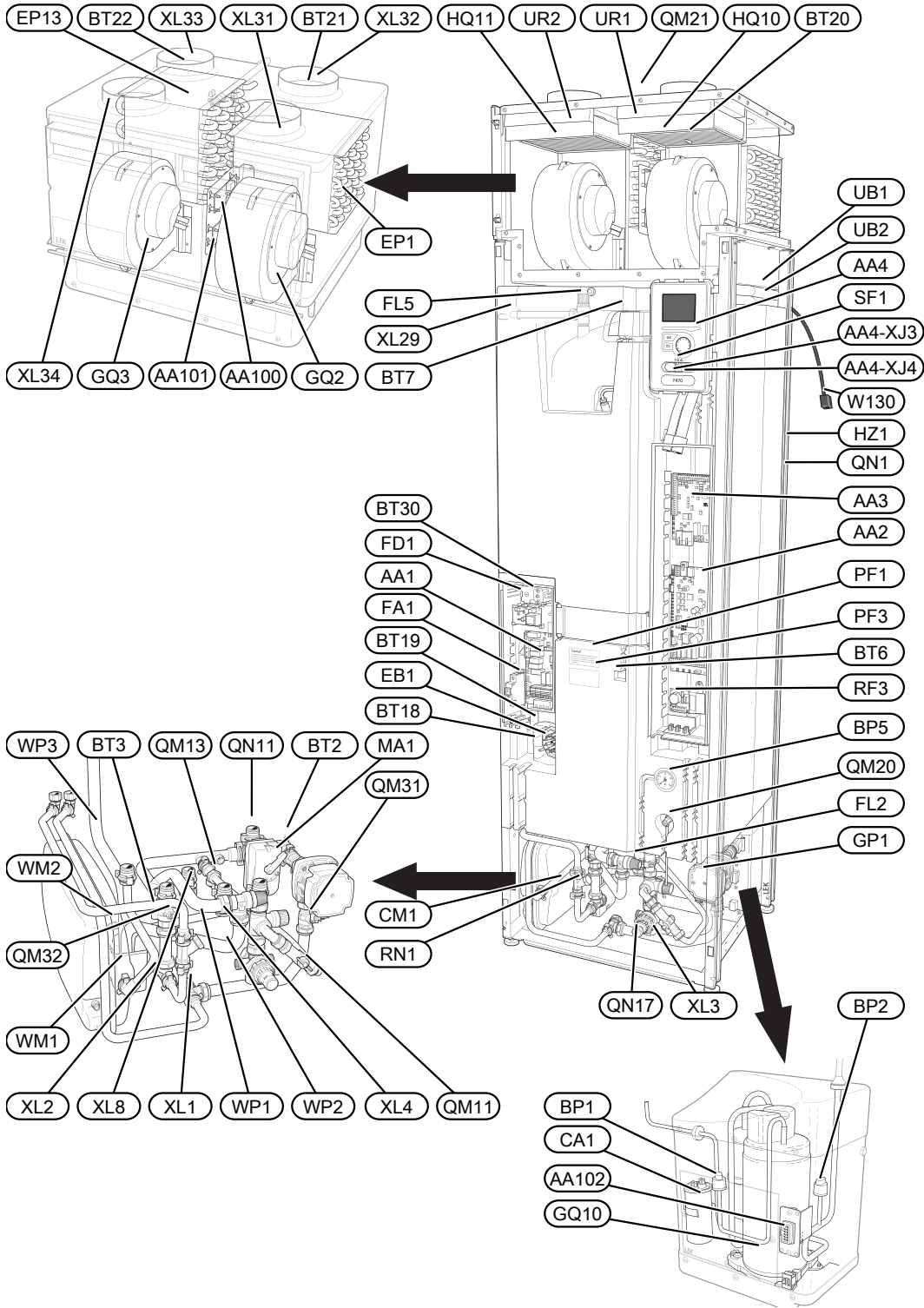

Pipe connections

XL1	Connection, heating medium flow line
XL2	Connection, heating medium return line
XL3	Connection, cold water
XL4	Connection, hot water
XL8	Connection, docking in
XL29	Connection, T&P valve (UK only)
XL31	Ventilation connection, exhaust air
XL32	Ventilation connection, extract air
XL33	Ventilation connection, supply air
XL34	Ventilation connection, outdoor air

HVAC components

CM1	Expansion vessel
EP13	Supply air battery
FL1	Expansion relief valve, safety valve, hot water heater
FL2	Safety valve, climate system
FL5	T&P valve (UK only)
GP1	Circulation pump
QM11	Filler valve, climate system
QM13	Filler valve 2, climate system
QM20	Venting, heating medium
QM21	Venting, supply air coil ¹
QM31	Shut-off valve, heating medium flow
QM32	Shut off valve, heating medium return
QN11	Shunt valve
QN17	Pressure reduction valve with integrated non-return valve (UK only)
RN1	Trim valve
WM1	Overflow cup
WM2	Overflow water discharge
WP1	Overflow pipe, safety valve hot water heater
WP2	Overflow pipe, safety valve climate system
WP3	Overflow pipe, condensation

Sensors etc.

BP1	High pressure pressostat
BP2	Low pressure pressostat
BP5	Pressure gauge, heating system
BT1	Outside sensor ¹
BT2	Temperature sensors, heating medium flow
BT3	Temperature sensors, heating medium return
BT6	Temperature sensor, hot water, control
BT7	Temperature sensor, hot water, display
BT16	Temperature sensor, evaporator ¹
BT18	Temperature sensor, compressor operation
BT19	Temperature sensor, immersion heater operation
BT20	Temperature sensor, exhaust air
BT21	Temperature sensor, extract air

BT22	Temperature sensor, supply air
BT30	Thermostat, backup heating
BT50	Room sensor ¹

Electrical components

AA1	Immersion heater card
AA2	Base card
AA3	Input circuit board
AA4	Display unit
	AA4-XJ3 USB socket
	AA4-XJ4 Service socket
AA100	Connection card air treatment section, exhaust air
AA101	Connection card air treatment section, supply air
AA102	Connection card compressor card
CA1	Capacitor
EB1	Immersion heater
FA1	Miniature circuit-breaker
FA2	Miniature circuit-breaker
FD1	Temperature limiter
MA1	Shunt motor with hand wheel
RF3	EMC-filter
SF1	Switch
W130	Network cable for NIBE Uplink™

Cooling components

EP1	Evaporator
GQ10	Compressor
HZ1	Drying filter with tank ¹
QN1	Expansion valve ¹

Ventilation

GQ2	Exhaust air fan
GQ3	Supply air fan
HQ10	Exhaust air filter ¹
HQ11	Supply air filter ¹
UR1	Filter cover, exhaust air
UR2	Filter cover, supply air

Miscellaneous

PF1	Rating plate
PF3	Serial number plate
UB1-2	Cable gland

¹Not visible in the image

Designations in component locations according to standard IEC 81346-2.

4 Pipe and ventilation connections

General pipe connections

Pipe installation must be carried out in accordance with current norms and directives.

The system requires the radiator circuit to be designed for a low temperature heating medium. At the lowest dimensioned outdoor temperature (DOT) the highest recommended temperatures are 55 °C on the supply line and 45 °C on the return line.

- NOTE**
The pipe system needs to be flushed out before the heat pump is connected so that any debris cannot damage component parts.
- NOTE**
This installation is subject to building regulation approval, notify the local Authority of intention to install.
- NOTE**
Use only manufacturer's recommended replacement parts.

Overflow water from the safety valves and the evaporator's collection tray passes via a non-pressurised overflow pipe to a drain, so that hot water splashes cannot cause injury. The mouth of the overflow pipe must be visible and not placed close to electrical components. In addition, the mouth of the overflow pipe (tundish), drain valves and motorised valves should be positioned away from all electrical components. This is the only permitted use of non-pressurised overflow pipe. Overflow pipes from tundish connected to the expansion relief valve must also be connected to the drain in the same way.

Please note that the connection of the T&P-valve should not be used for any other purpose.

Valves may not be positioned between the safety valve and the water heater.

Overflow pipes from tundish must be routed with a fall and be at least 300 mm long, before bends or angles in the pipework (see image) and must also be frost-proof.

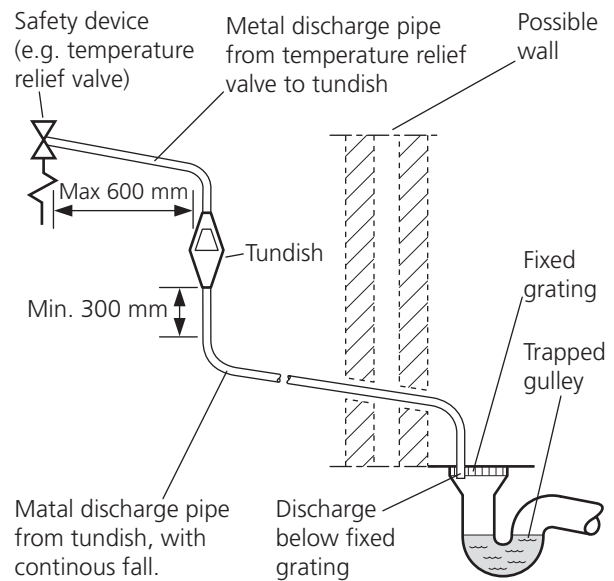

Valve outlet size	Minimum size of discharge pipe	Minimum size of discharge pipe from tundish	Maximum resistance allowed, expressed as a length of straight pipe (i.e. no elbows or bends)	Resistance created by each elbow or bend
G1/2	15 mm	22 mm	up to 9 m	0.8 mm
G1/2	15 mm	28 mm	up to 18 m	1.0 mm
G1/2	15 mm	35 mm	up to 27 m	1.4 mm
<G3>/4	22 mm	28 mm	up to 9 m	1.0 mm
<G3>/4	22 mm	35 mm	up to 18 m	1.4 mm
<G3>/4	22 mm	42 mm	up to 27 m	1.7 mm
G1	28 mm	35 mm	up to 9 m	1.4 mm
G1	28 mm	42 mm	up to 18 m	1.7 mm
G1	28 mm	54 mm	up to 27 m	2.3 mm

Hard water areas

Usually, there should not be a problem in installing F470 in areas of hard water as the operating temperature is 50-60 °C.

Cleaning the climate system

When the water heater and the climate system have been filled with water, F470 must operate at maximum normal temperature for at least one hour. Thereafter the system must be drained of water and refilled. See section Draining the climate system on page 49.

Before installing the heat pump in an existing system, it is important that the system is properly flushed through.

Even if the heat pump is to be installed in a new system, the heat pump and system should be flushed.

NOTE

Ensure that cleaning agent has been removed from the entire system before adding inhibitor.

After flushing an inhibitor should be used for long-term anti-corrosion protection.

NIBE Energy Systems Limited recommends water treatments (supplied by e.g. Fernox and Sentinel) specifically designed for heat pumps.

Caution

Ensure that incoming water is clean. When using a private well, it may be necessary to supplement with an extra water filter.

Max. volume in the heating section and the climate system

The volume of the pressure expansion vessel (CM1) is 10 litres and it is pre-pressurised as standard to 0.5 bar (5 mvp). As a result, the maximum permitted height "H" between the expansion vessel and the highest installed radiator is 5 m, see figure.

If the pre-pressure is not high enough, it can be increased by adding air via the valve in the expansion vessel. The expansion vessel's pre-pressure must be stated in the inspection document. Any change in the pre-pressure affects the ability of the expansion vessel to handle the expansion of the water.

The maximum system volume, excluding the heating section, is 219 litres at the above pre-pressure.

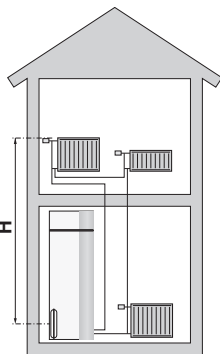

System diagram

F470 consists of a heat pump, water heater, immersion heater, fans, circulation pump and control system. F470 is connected to the ventilation system and heating medium circuit.

When the exhaust air at room temperature passes through the evaporator, the refrigerant evaporates because of its low boiling point. In this way the energy in the room air is transferred to the refrigerant.

The refrigerant is then compressed in a compressor, causing the temperature to rise considerably.

The warm refrigerant is led to the condenser. Here the refrigerant gives off its energy to the heating system water, whereupon the refrigerant changes state from gas to liquid.

The refrigerant then goes via filters to the expansion valve, where the pressure and temperature are reduced.

The refrigerant has now completed its circulation and returns to the evaporator.

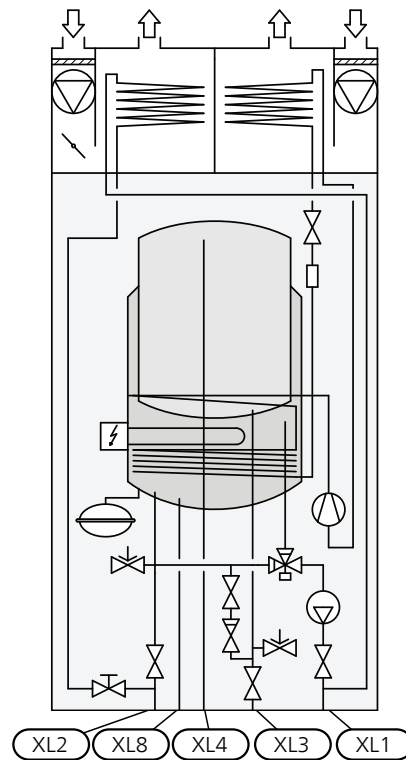

- XL1 Connection, heating medium flow
- XL2 Connection, heating medium return
- XL3 Connection, cold water
- XL4 Connection, hot water
- XL8 Connection, docking

Caution

This is an outline diagram, differences may occur in the actual installation.

Dimensions and pipe connections

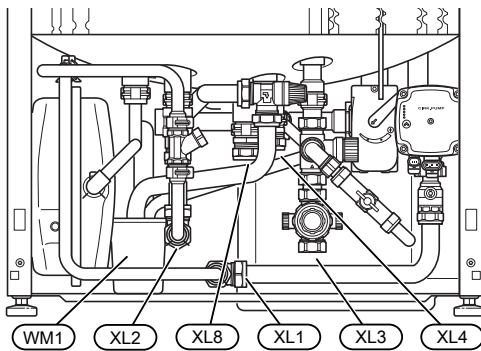
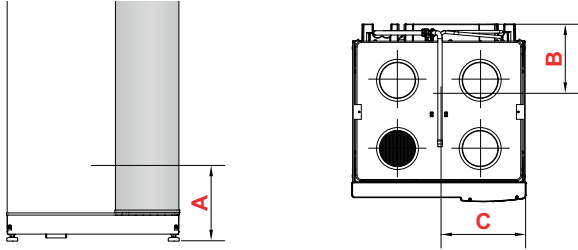













Setting out dimensions

Connection		A	B	C
XL1 Heating medium supply	(mm)	30	465	320
XL2 Heating medium return	(mm)	45	420	365
XL3 Cold water	(mm)	80	455	210
XL4 Hot water	(mm)	170	400	260
XL8 Docking	(mm)	175	290	295
WM1 Overflow cup	(mm)	60	200	420

Pipe dimensions

Connection		
XL1-XL2 Heating medium ext Ø	(mm)	22
XL3 Cold water ext Ø	(mm)	22
XL4 Hot water ext Ø	(mm)	22
XL8 Docking ext. Ø	(mm)	22
WM2 Overflow water discharge	(mm)	32

Symbol key

Symbol	Meaning
	Shut-off valve
	Non-return valve
	Mixing valve
	Shunt / shuttle valve
	Safety valve
	Tundish
	Temperature sensor
	Circulation pump
	Particle filter
	Radiator system
	Domestic hot water
	Under floor heating systems

Cold and hot water

Connecting cold and hot water

- A mixer valve must also be installed, if the factory setting for hot water is changed. National regulations must be observed.
- The setting for hot water is made in menu 5.1.1 (page 44).

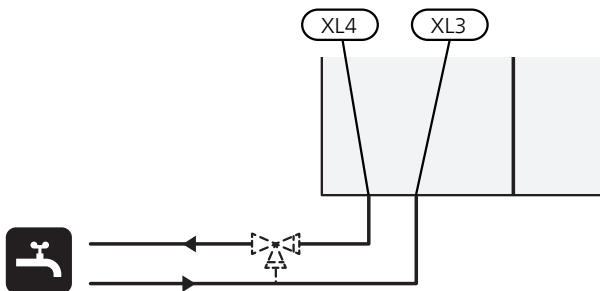

Heating medium side

Connecting the climate system

A climate system is a system that regulates indoor comfort with the help of the control system in F470 and for example radiators, under floor heating/cooling, fan coils etc.

- When connecting to a system with thermostats on all radiators, a relief valve must be fitted, or some of the thermostats must be removed to ensure sufficient flow.

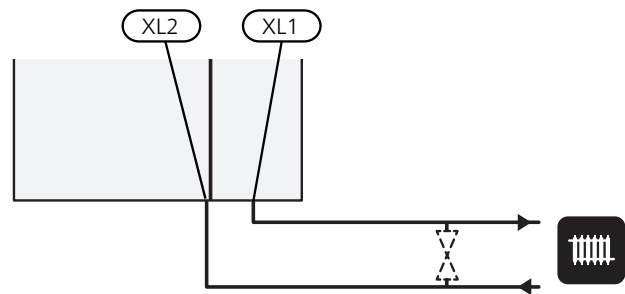

Supply air battery

The supply air coil is connected in parallel with the radiator circuit and heats the building's supply air. The water flow through the supply air coil is set by means of a trim valve (RN1). The supply air temperature must be approximately the same as the indoor temperature, preferably a few degrees lower.



TIP

If possible, choose a cold day to adjust the trim valve.

Installation alternative

F470 can be installed in several different ways, some of which are shown below.

Further option information is available at www.nibe.co.uk and in the respective assembly instruction for the accessory used. See page 55 for a list of accessories that can be used with F470.

Extra hot water heaters

The heat pump should be supplemented with an extra water heater, if a large bath tub or other significant consumer of hot water is installed.

Water heater with immersion heater

If it is possible to use a water heater with an immersion heater, connect it as illustrated below.

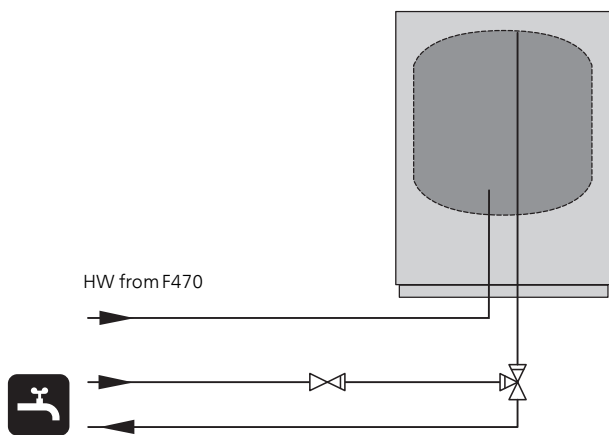

Hot water circulation (VVC)

To reduce the risk of bacterial growth in systems with hot water circulation, the temperature of the circulating water should not fall below 50°C. Nor should there be any hot water pipes containing stationary water. Adjust the hot water system so that the temperature does not fall below 50°C at the extremities of the system.

The circulation pump for hot water circulation can be controlled by the heat pump. The HWC return is connected to a freestanding water heater.

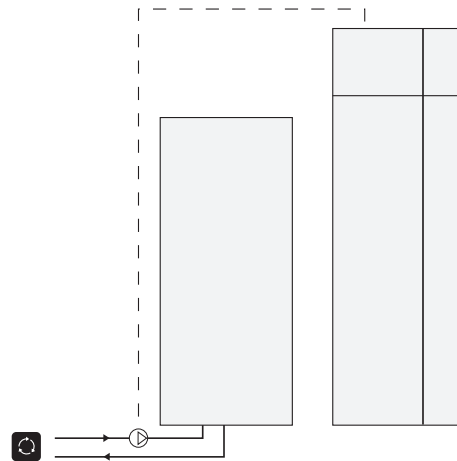

Two or more climate systems

When more than one climate system is to be heated, the following connection can be used.

The ECS 40/ECS 41 accessory is required for this connection.

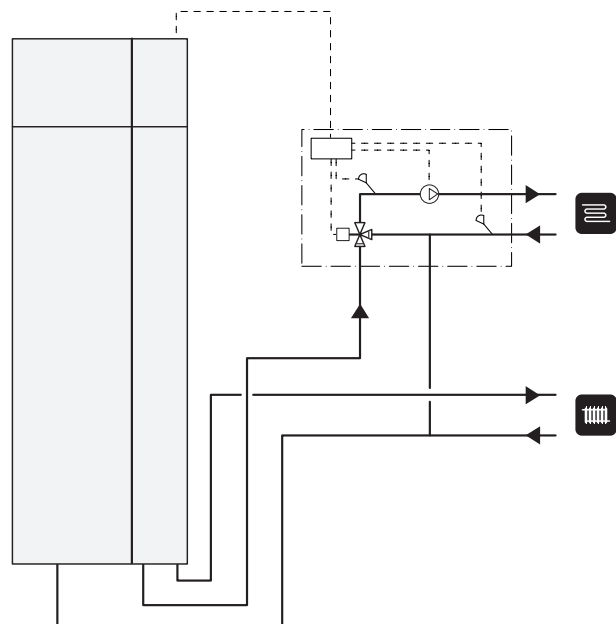

General ventilation connection

- Ventilation installation must be carried out in accordance with current norms and directives.
- Connections must be made via flexible hoses, which should be installed so that they are easy to replace.
- Provision must be made for inspection and cleaning of the duct.
- Make sure that there are no reductions of cross-sectional area in the form of creases, tight bends, etc., since this will reduce the ventilation capacity.
- The air duct system must be a minimum of air tightness class B.
- To prevent fan noise being transferred to the ventilation devices, silencers should be installed in the duct system. In the event of ventilation devices in noise-sensitive rooms, silencers must be installed.
- The extract air and outdoor air ducts are insulated using diffusion-proof material along their entire lengths.
- Ensure that the condensation insulation is fully sealed at any joints and/or at lead-in nipples, silencers, roof cowls or similar.
- The air has to be routed to the outdoor air duct through an outer wall grille in the facade. The outer wall grille must be installed so that it is protected from the weather and must be designed so that no rainwater can penetrate the facade or follow the air into the duct.
- When positioning the outdoor air and extract air hood/grille, bear in mind that the two air flows must not short circuit to prevent the extract air from being drawn into F470 again.
- The extract air duct must be a maximum of 20 m long with a maximum of six bends.
- Because the heat pump contains the flammable refrigerant propane (R290), the air ducting system must be earthed. This is achieved by making a good electrical connection to the four ventilation ducts using the enclosed earth cables (4 pcs). The cables must then be connected to the earth pins on top of the top cover.
- A duct in a masonry chimney stack must not be used for extract air.
- When external devices that affect the ventilation are used, for example kitchen fans and stoves, the heat pump must be in operation. There is a risk of freezing at low outdoor temperatures.

Exhaust air duct /kitchen fan

Exhaust air duct (kitchen fan) must not be connected to F470.

To prevent cooking odours from being led to the F470, the distance between the kitchen fan and the exhaust air valve must be observed. The distance should not be less than 1.5 m.

Always use a kitchen fan when cooking.

Ventilation flow

Connect F470 so that all the exhaust air, except kitchen duct air (kitchen fan), passes through the evaporator (EP1) in the heat pump.

The ventilation flow must comply with the applicable national standards.

For optimum heat pump performance, the ventilation flow must not be less than 28 l/s (100 m³/h) at an exhaust air temperature of at least 20°C. When the exhaust air temperature is lower than 20°C (for example at start-up and when there is nobody at home), the minimum value is 31 l/s (110 m³/h).

The supply air flow must be lower than the exhaust air flow to prevent over pressure in the house.

The heat pump's installation area must be ventilated to at least 5 l/s (18 m³/h)

Set the ventilation capacity in the heat pump's menu system (menu 5.1.5).

If the exhaust air temperature falls below 16°C, the compressor is blocked and electric additional heat is permitted. No energy is recovered from the exhaust air when the compressor is blocked.

Adjusting ventilation

To obtain the necessary air exchange in every room of the house, the exhaust air device and the supply air device must be correctly positioned and adjusted and the fans in the heat pump adjusted.

Immediately after installation adjust the ventilation so that it is set according to the projected value of the house.

Incorrect adjustment of the ventilation may lead to reduced installation efficiency and thus poorer operating economy, and may cause moisture damage in the building

Dimension and ventilation connections

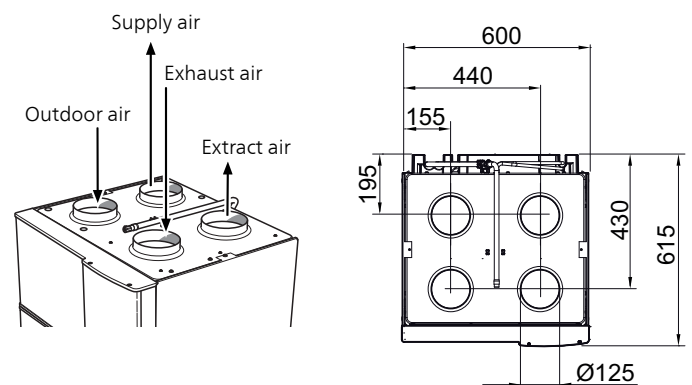

5 Electrical connections

General

All electrical equipment, except the outdoor temperature sensors and room temperature sensors are ready connected at the factory.

- Disconnect the heat pump before any insulation test of the house wiring is carried out.
- F470 must be equipped with a separate earth-fault breaker (30 mA).
- If a miniature circuit breaker is used, this should have at least motor characteristic "C". See table on page 26 for fuse size.
- For the heat pump wiring diagram, see page 61.
- Communication and sensor cables to external connections must not be laid close to high current cables.
- The minimum area of communication and sensor cables to external connections must be 0.5 mm² up to 50 m, for example EKKX or LiYY or equivalent.
- When cable routing in F470, cable grommets UB1 and UB2, (marked in image) must be used. In UB1 and UB2 the cables are inserted through the heat pump from the back to the front. For dimensions diagram see page 24.

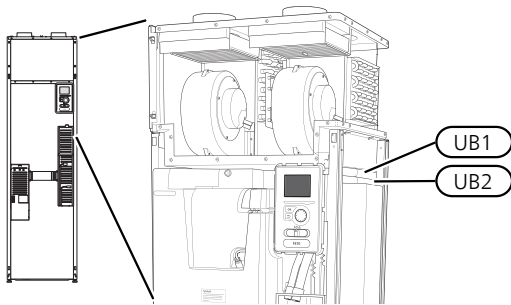

NOTE

Switch (SF1) must not be moved to "I" or "⚠" until F470 has been filled with water. Otherwise the temperature limiter, thermostat and the immersion heater may be damaged.



NOTE

Check the connections, main voltage and phase voltage before the machine is started, to prevent damage to the heat pump electronics.



NOTE

If the supply cable is damaged, only NIBE, its service representative or similar authorised person may replace it to prevent any danger and damage.



NOTE

Electrical installation and service must be carried out under the supervision of a qualified electrician. Cut the current with the circuit breaker before carrying out any servicing. Electrical installation and wiring must be carried out in accordance with the stipulations in force.

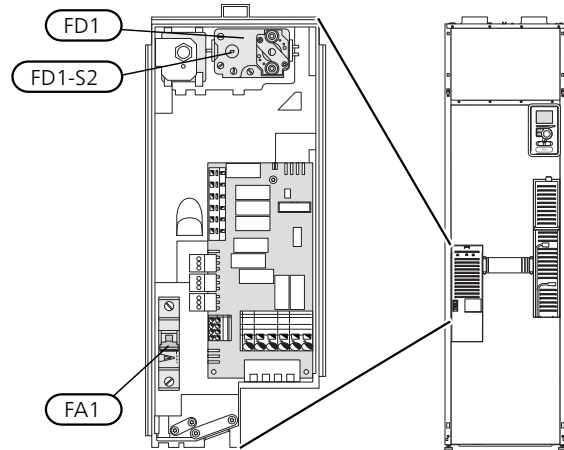

Miniature circuit breaker (FA1)

Control (230 V), fans, compressor, circulation pump etc. are internally fused by a miniature circuit breaker (FA1).



Caution

Check the miniature circuit-breaker (FA1). It may have tripped during transportation.

Temperature limiter (FD1)

The temperature limiter (FD1) cuts the current supply to the electric additional heat if the temperature rises between 90 and 100°C and can be manually reset.

Resetting

The temperature limiter (FD1) is accessible behind the front cover. Reset the temperature limiter by carefully pressing the button (FD1-SF2) using a small screwdriver.

Temperature limiter, compressor (FD2)

Temperature limiter (FD2) cuts the current supply to the soft starter if the temperature rises above 88 °C and is manually reset.

Resetting

Temperature limiter (FD2) is accessible behind the front cover. The temperature limiter is reset by firmly pressing in its button (FD2-SF2) using a small screwdriver.

Accessibility, electrical connection

The plastic cap of the electrical boxes is opened using a screwdriver.



NOTE

The cover for the input card is opened without a tool.

Removing the cover, input board

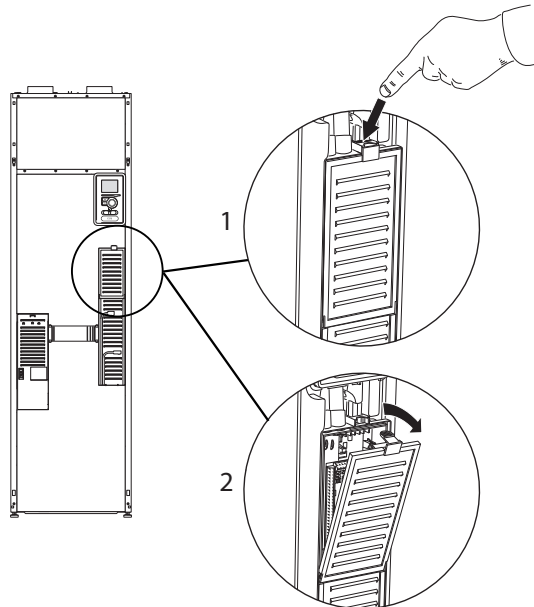

1. Push the catch down.
2. Angle out the cover and remove it.

Removing the cover, immersion heater board

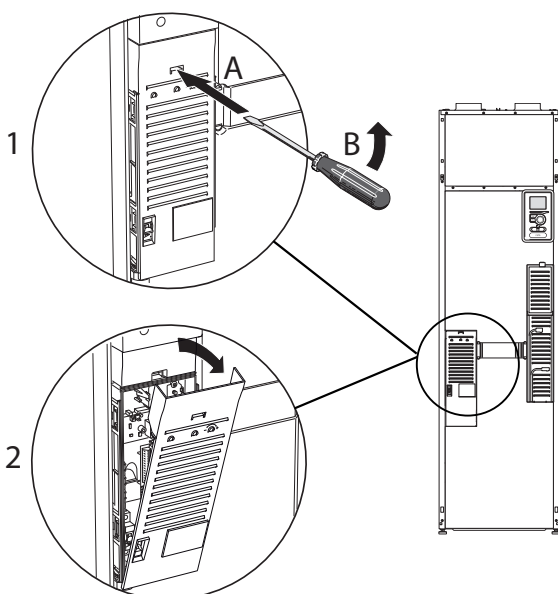

1. Insert the screwdriver (A) and pry the catch carefully downwards (B).
2. Angle out the cover and remove it.

Removing the cover, base circuit board



Caution

To remove the cover for the base board, the cover for the input circuit board must first be removed.

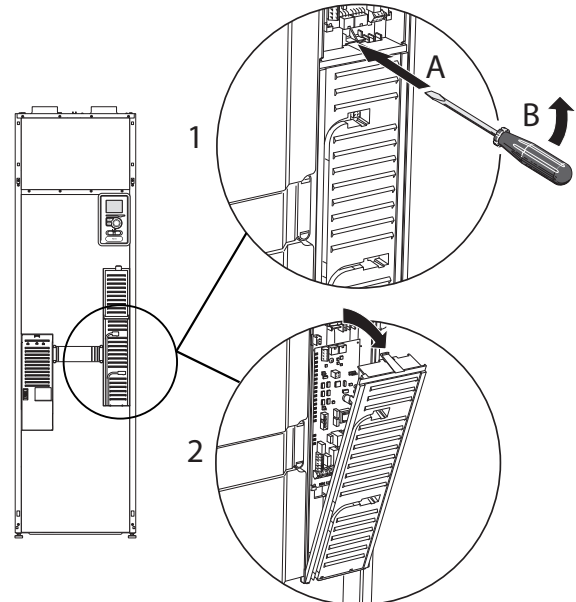

1. Insert the screwdriver (A) and pry the catch carefully downwards (B).
2. Angle out the cover and remove it.

Cable lock

Use a suitable tool to release/lock cables in the heat pump terminal blocks.

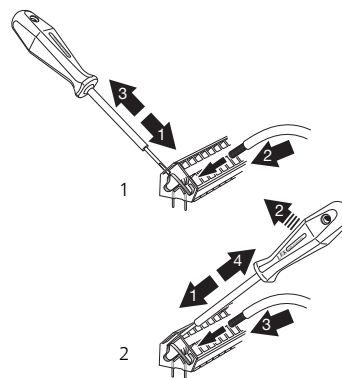

Connections



NOTE

To prevent interference, unscreened communication and/or sensor cables to external connections must not be laid closer than 20 cm from high voltage cables.

Power connection

F470 must be installed via an isolator switch with a minimum breaking gap of 3mm. Minimum cable area must be sized according to the fuse rating used. Supplied cable (length approx. 2 m) for incoming supply electricity is connected to terminal block X1 on the immersion heater board (AA1). The connection cable can be found on the back of F470 (see dimensions diagram below).

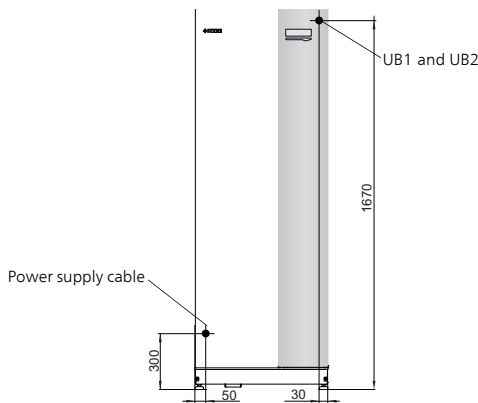

Outside sensor

Install the outdoor temperature sensor (BT1) in the shade on a wall facing north or north-west, so it is unaffected by the morning sun for example.

Connect the sensor to terminal block X6:1 and X6:2 on the input board (AA3). Use a twin core cable of at least 0.5 mm² cable area.

If a conduit is used it must be sealed to prevent condensation in the sensor capsule.

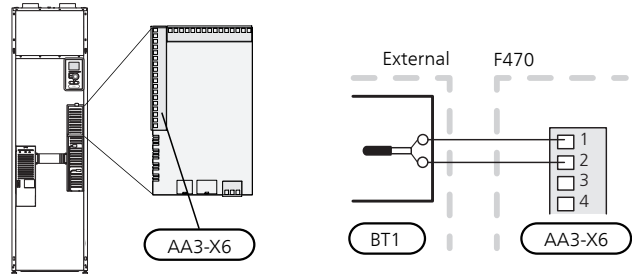

Connection 1x230V

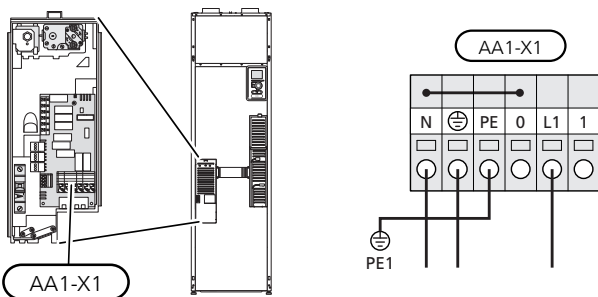

Tariff control

If the voltage to the immersion heater and/or the compressor disappears for a certain period, there must also be blocking via the AUX-input at the same time, see "Possible selection for AUX inputs".

Room sensor

F470 is supplied with a room sensor enclosed (BT50). The room sensor has a number of functions:

1. Shows current room temperature in the display on F470.
2. Option of changing the room temperature in °C.
3. Provides the option of fine-tuning the room temperature.

Install the sensor in a neutral position where the set temperature is required. A suitable location is on a free inner wall in a hall approx. 1.5 m above the floor. It is important that the sensor is not obstructed from measuring the correct room temperature by being located, for example, in a recess, between shelves, behind a curtain, above or close to a heat source, in a draft from an external door or in direct sunlight. Closed radiator thermostats can also cause problems.

The heat pump operates without the sensor, but if one wishes to read off the accommodation's indoor temperature in F470's display, the sensor must be installed. Connect the room sensor to X6:3 and X6:4 on the input board (AA3).

If the sensor is to be used to change the room temperature in °C and/or to fine-tune the room temperature, the sensor must be activated in menu 1.9.4.

If the room sensor is used in a room with underfloor heating, it should only have an indicative function, not control of the room temperature.

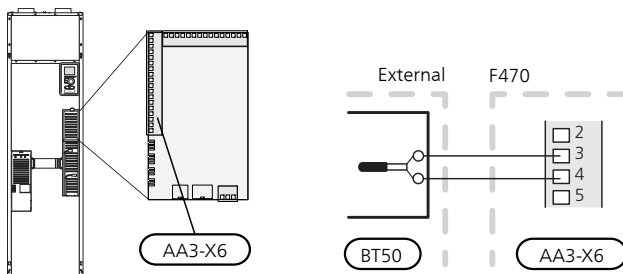

Caution

Changes of temperature in accommodation take time. For example, short time periods in combination with underfloor heating will not give a noticeable difference in room temperature.

Settings

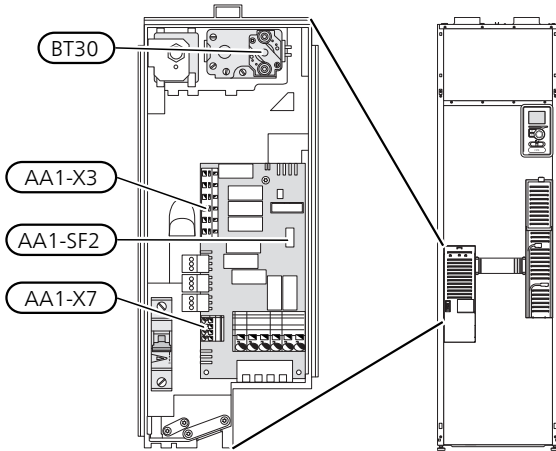

Electrical addition - maximum output

The immersion heater output is divided into steps, according to the table.

Setting maximum output in the electric additional heat is done in menu 5.1.12.

Power steps of the immersion heater

Electrical addition (kW)	Max (A)
0.0	6.3
2.7	17.9
5.3*	29.3
8.0	41

*Factory setting

The table displays the maximum phase current for the relevant power step for the heat pump.

Emergency mode

When the heat pump is set to emergency mode (SF1 is set to Δ), only the most necessary functions are activated.

- The compressor and fans are off and heating is managed by the immersion heater.

Power in emergency mode

The immersion heater's output in emergency mode is set with the dipswitch (S2) on the immersion heater circuit board (AA1) according to the table below.

kW	1	2	3	4	5	6
2.7	on	off	off	off	off	off
5.3*	on	off	on	off	off	off
8.0	on	off	on	off	on	off

*Default value

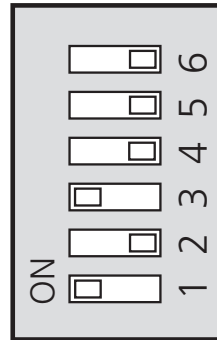

The image shows the dip-switch (AA1-S2) in the factory setting.

Optional connections

Load monitor

Integrated load monitor

F470 is equipped with a simple form of integrated load monitor, which limits the power steps for the electric additional heat by calculating whether future power steps can be connected to the relevant phase without the specified main fuse being exceeded. In those cases where the current would exceed the specified main fuse, the power step is not permitted. The size of the property's main fuse is specified in menu 5.1.12.

NIBE Uplink

Connect the network connected cable (straight, Cat.5e UTP) with RJ45-contact (male) to RJ45 contact (female) on the rear of the heat pump.



External connection options

F470 has software-controlled AUX inputs and outputs on the input board (AA3), for connecting the external switch function or sensor. This means that when an external switch function (the switch must be potential-free) or sensor is connected to one of six special connections, this function must be selected for the correct connection in menu 5.4.

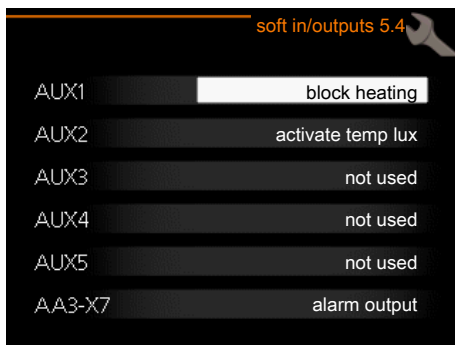

For certain functions, accessories may be required.

Selectable inputs

Selectable inputs on the input board for these functions are:

AUX1	AA3-X6:9-10
AUX2	AA3-X6:11-12
AUX3	AA3-X6:13-14
AUX4	AA3-X6:15-16

AUX5

AA3-X6:17-18

Selectable outputs

A selectable output is AA3-X7.

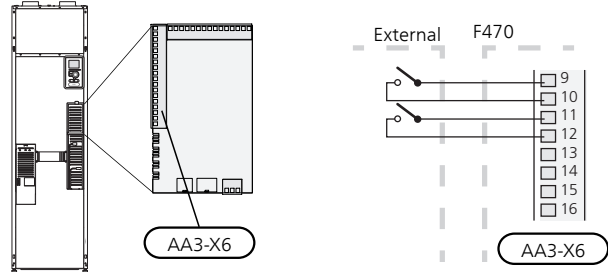

The example above uses the inputs AUX1 (X6:9-10) and AUX2 (X6:11-12) on the input board (AA3).



Caution

Some of the following functions can also be activated and scheduled via menu settings.

Possible selection for AUX inputs

Temperature sensor

Temperature sensor can be connected to F470. Use a 2-core cable of at least 0.5 mm² cable area.

Available options are:

- room sensor (RTS 40)

Monitor

Available options are:

- level monitor for the overflow cup (NO)
- alarm from external units. The alarm is connected to the control, which means that the malfunction is presented as an info-alarm in the display. Potential-free signal of type NO or NC.

External blocking of functions

An external switch function can be connected to F470 for blocking various functions. The switch must be potential-free and a closed switch results in blocking.



Caution

Blocking entails a risk of freezing.

Functions that can be blocked:

- hot water (hot water production)
- heating (blocking of heating demand)
- additional heat (additional heat is blocked)
- compressor
- tariff blocking (additional heat, compressor, heating and hot water are disconnected)

External activation of functions

An external switch function can be connected to F470 to activate various functions. The function is activated during the time the switch is closed.

Possible functions that can be activated:

- hot water function "temporary lux"
- hot water comfort mode "economy"
- "external adjustment"

An external contact function can be connected to F470 to change the supply temperature and the room temperature.

When the switch is closed, the temperature changes in °C (if the room sensor is connected and activated). If a room sensor is not connected or not activated, the desired change of "temperature" (heating curve offset) is set with the number of steps selected. The value is adjustable between -10 and +10. External adjustment of climate systems 2 to 8 requires accessories.

– *climate system 1 to 8*

The value for the change is set in menu 1.9.2, "external adjustment".

- activation of one of four fan speeds.

The following five options are available:

- 1-4 is normally open (NO)
- 1 normally closed (NC)

The fan speed is activated during the time the switch is closed. Normal speed is resumed when the switch is opened again.

- SG ready



Caution

This function can only be used in mains networks that support the "SG Ready"-standard

"SG Ready" requires two AUX inputs.

"SG Ready" is a smart form of tariff control where your electricity supplier can affect the indoor and hot water temperatures or simply block the additional heat and/or the compressor in the heat pump at certain times of the day (can be selected in menu 4.1.5 after the function is activated). Activate the function by connecting potential-free switch functions to two inputs selected in menu 5.4 (SG Ready A and SG Ready B).

Closed or open switch means one of the following:

– **Blocking (A: Closed, B: Open)**

"SG Ready" is active. The compressor in the heat pump and additional heat is blocked like the day's tariff blocking.

– **Normal mode (A: Open, B: Open)**

"SG Ready" is not active. No effect on the system.

– **Low price mode (A: Open, B: Closed)**

"SG Ready" is active. The system focuses on costs savings and can for example exploit a low tariff from the electricity supplier or over-capacity from any own power source (effect on the system can be adjusted in the menu 4.1.5).

– **Overcapacity mode (A: Closed, B: Closed)**

"SG Ready" is active. The system is permitted to run at full capacity at over capacity (very low price) with the electricity supplier (effect on the system is settable in menu 4.1.5).

(A = SG Ready A and B = SG Ready B)

- +Adjust

Using +Adjust, the installation communicates with the underfloor heating's control centre* and adjusts the heating curve and calculated supply temperature according to the underfloor heating system's reconnection.

Activate the climate system you want +Adjust to affect by highlighting the function and pressing the OK button.

*Support for +Adjust required



Caution

This accessory may require a software update in your F470. The version can be checked in the "Service info" menu 3.1. Visit <http://www.nibeuplink.com> and click on the "Software" tab to download the latest software to your installation.



Caution

In systems with both under floor heating and radiators, NIBE ECS 40/41 should be used for optimum operation.

Possible selections for AUX output

It is possible to have an external connection through the relay function via a potential-free switching relay (max. 2 A) on the input board (AA3), terminal block X7. The function must be activated in menu 5.4.

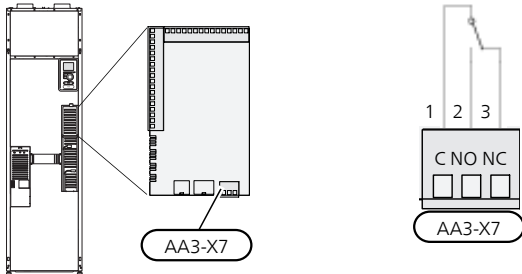

The picture shows the relay in the alarm position.

When the switch (SF1) is in the “⏻” or “⚠” position, the relay goes to NC.

Caution

The relay outputs may be subjected to a max load of 2 A at resistive load (230V AC).



TIP

The accessory AXC is required if more than one function is to be connected to the AUX output.

Optional functions for external connection:

Indication

- alarm indication
- holiday indication

Control

- control of circulation pump for hot water circulation
- control of external circulation pump (for heating medium)
- control of external damper for anti-freeze

Activation

- activation of away mode for smart home (complement to the functions in menu 4.1.7)

Blocking

- blocking of supply air heating (accessory BSA 10 is required)



Caution

The relevant distribution box must be marked with a warning about external voltage.

An external circulation pump is connected to the AUX output, as illustrated below.

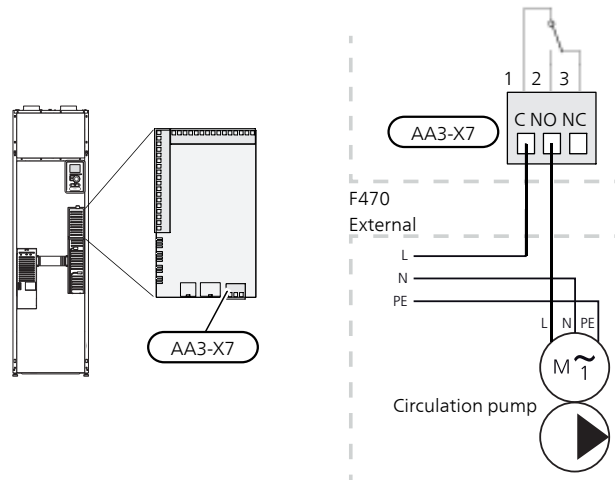

Connecting accessories

Instructions for connecting accessories are provided in the manual accompanying the accessory. See page 55 for the list of the accessories that can be used with F470.

6 Commissioning and adjusting

Preparations

1. Check that the switch (SF1) is in position "⏻".
2. Check that the filling valve (QM11) is fully closed.



Caution

Check the miniature circuit-breaker (FA1) in the heat pump. It may have tripped during transportation.

Filling and venting

Filling the hot water heater

1. Open a hot water tap in the house.
2. Open the externally mounted filler valve. This valve should then be fully open during operations.
3. When water comes out of the hot water tap, the hot water heater is full and the tap can be closed.

Filling the climate system

1. Check that the shut-off valves for the heating system (QM31) and (QM32) are open.
2. Open the vent valves (QM20) and (QM21).
3. Check that the supplied flexi hose is connected between connection (QM11) and connection (QM13). Connect the hose if this has not been done.
4. Open the filler valves (QM11), (QM13). The heating section and the rest of the climate system are filled with water.
5. When the water exiting the vent valves (QM20) and (QM21) is no longer mixed with air, close the valves. After a while, the pressure rises on the pressure gauge (BP5). When the pressure reaches 2.5 bar (0.25 MPa), the safety valve (FL2) starts to release water. Close the filler valves (QM11) and (QM13).
6. Reduce the boiler pressure to the normal working range (approx. 1 bar) by opening the vent valves (QM20) and (QM21) or the safety valve (FL2).
7. Check that there is water in the overflow cup (WM1).

If the overflow cup requires topping up:

1. Turn the safety valve for hot water (FL1) anticlockwise carefully.

Venting the climate system

1. Turn off the power supply to the heat pump.
2. Vent the heat pump via the vent valve (QM20) and the rest of the climate system via the relevant vent valves.
3. Vent the supply air battery via its vent valve (QM21).
4. Keep topping up and venting until all air has been removed and the pressure is correct.



NOTE

The vent pipe from the container must be drained of water before air can be released. This means that the system is not necessarily bled despite the flow of water when the bleed valve (QM20) is opened.

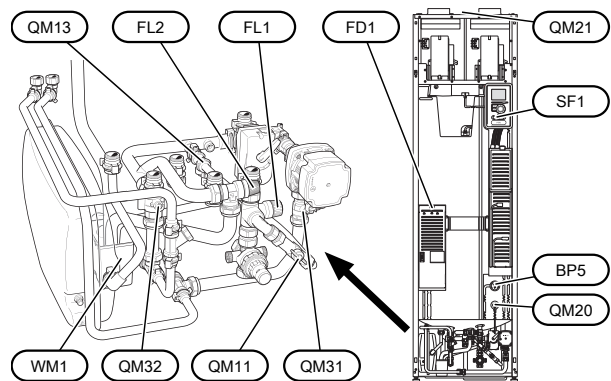

Start-up and inspection

Start guide



NOTE

There must be water in the climate system before the switch is set to "I".

1. Set switch (SF1) on F470 to position "I".
2. Follow the instructions in the display's start guide. If the start guide does not start when you start the F470, start it manually in menu 5.7.



TIP

See page 38 for a more in-depth introduction to the heat pump's control system (operation, menus etc.).

Commissioning

The first time the heat pump is started a start guide is started. The start guide instructions state what needs to be carried out at the first start together with a run through of the heat pump's basic settings.

The start guide ensures that start-up is carried out correctly and cannot be bypassed. The start guide can be started later in menu 5.7.



Caution

As long as the start guide is active, no function in the installation will start automatically.

The guide will appear at each installation re-start until it is deselected on the last page.

Operation in the start guide

A. Page

B. Name and menu number

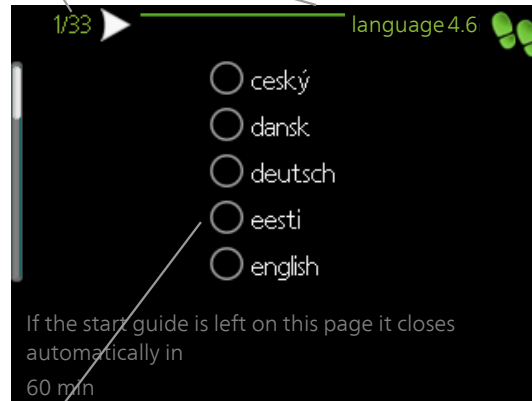

C. Option / setting

A. Page

Here you can see how far you have come in the start guide.

Scroll between the pages of the start guide as follows:

1. Turn the control knob until one of the arrows in the top left corner (at the page number) has been marked.
2. Press the OK button to skip between the pages in the start guide.

B. Name and menu number

Read what menu in the control system this page of the start guide is based on. The digits in brackets refer to the menu number in the control system.

If you want to read more about affected menus either consult the help menu or read the user manual.

C. Option / setting

Make settings for the system here.

D. Help menu



In many menus there is a symbol that indicates that extra help is available.

To access the help text:

1. Use the control knob to select the help symbol.
2. Press the OK button.

The help text often consists of several windows that you can scroll between using the control knob.

Setting the ventilation

Ventilation must be set according to applicable standards. The supply air flow is adjusted so that it is 80% of the exhaust air flow. The settings are made in menus 5.1.5 and 5.1.6.

Even if ventilation is roughly set at installation it is important that a ventilation adjustment is ordered and permitted.



NOTE

Order a ventilation adjustment to complete the setting.

Ventilation capacity, supply air

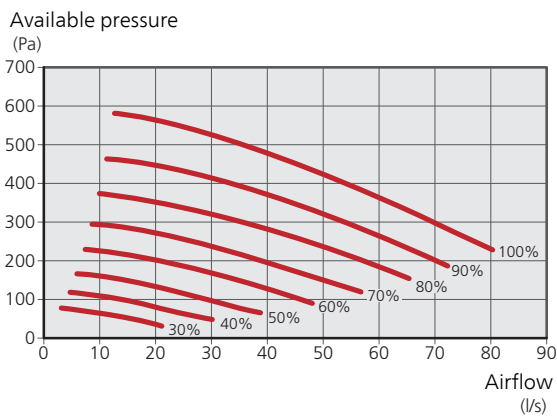

Fan output, supply air

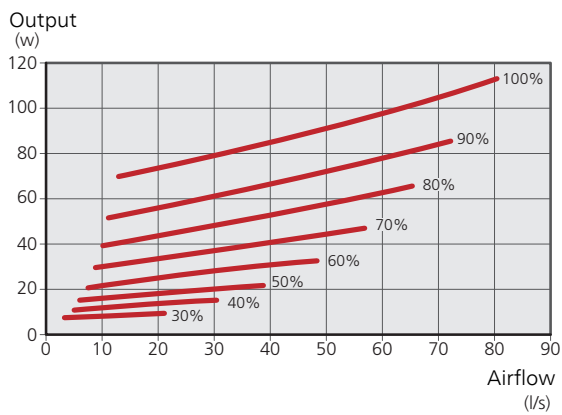

Ventilation capacity, exhaust air

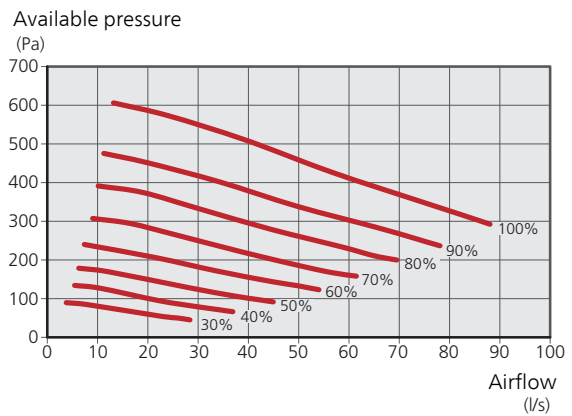

Fan output, exhaust air

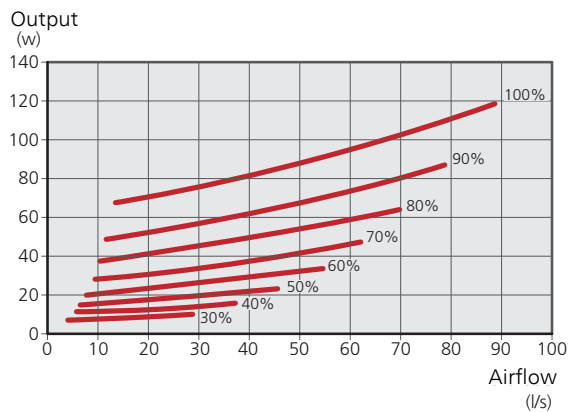

Supply air battery

The water flow through the supply air coil is set by means of a trim valve (RN1). This valve must be adjusted to prevent unnecessary energy consumption in the accommodation. The additional output is determined according

to the diagram below. The supply air temperature must be approximately the same as the indoor temperature, preferably a few degrees lower.



TIP

Post-adjust the trim valve on a cold day.

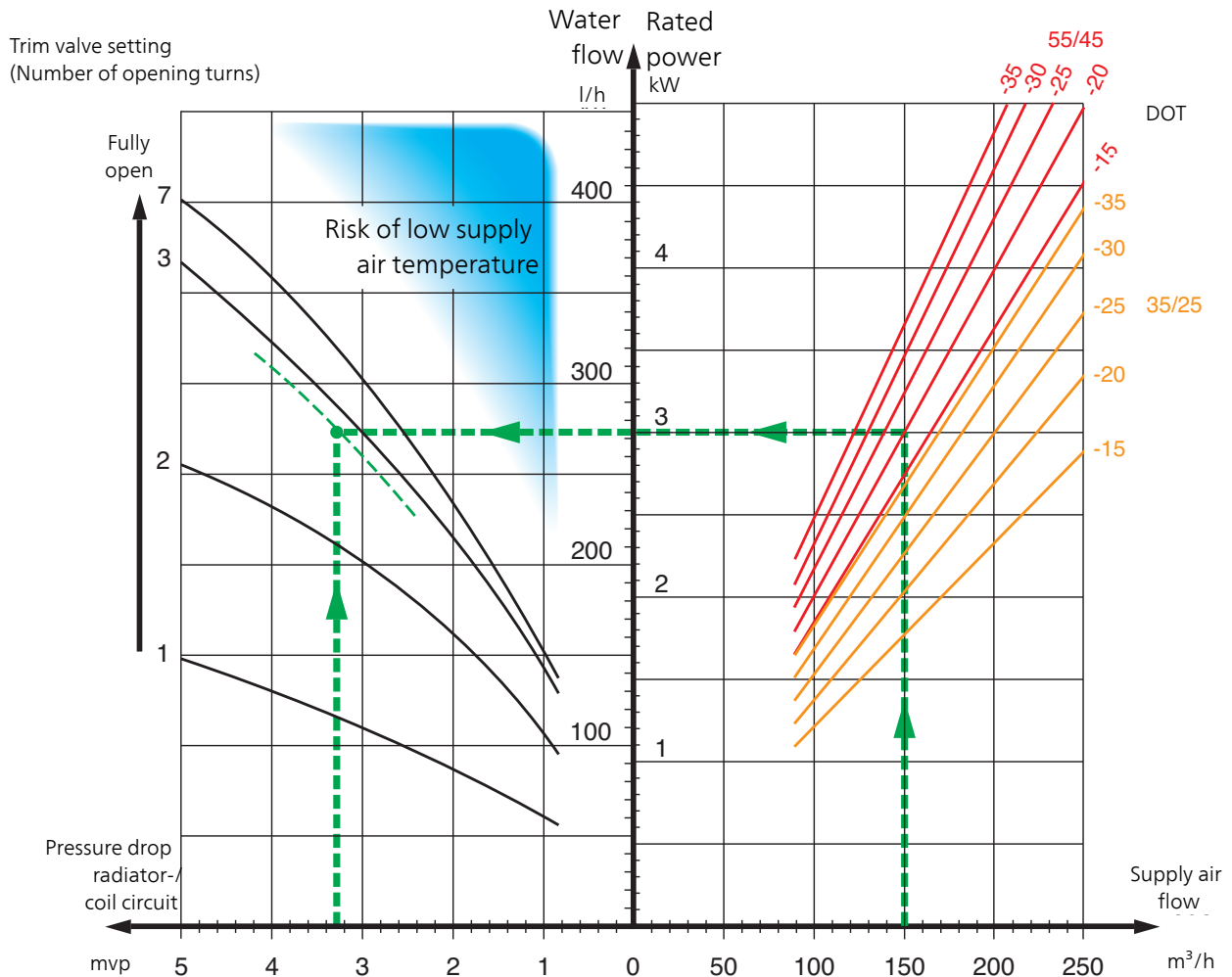

The delivered output in the diagram is calculated when dimensioning the heating system 55/45°C respective 35/25°C (underfloor heating).

Example: If the supply flow is regulated to 150 m³/h and DOT is -20 °C at a pump pressure (= pressure drop coil circuit) of 3.3 mvp (33 kPa), gives the setting 2.8 on the trim valve.

This means the trim valve must be opened 2.8 turns from the closed position. At the same time it can be read that the coil is supplying the supply air with approximately 3 kW of additional output at -20°C.



NOTE

Vent the coil using the venting screw (QM21) repeatedly in order to ensure the circulation through the coil.

Commissioning without fans

The heat pump can be run without recovery, as only an electric boiler, to produce heat and hot water, for example before the ventilation installation is complete.

Enter menu 4.2 - "op. mode" and select "add. heat only"

Enter menu 5.1.5 - "fan sp. exhaust air" and reduce the fan speed to 0%. Also go to menu 5.1.6 - "fan sp. supply air" and reduce the fan speed on the supply air fan to 0%.



NOTE

Select operating mode "auto" or "manual" when the heat pump is to run on recovery again.

Setting circulation pump

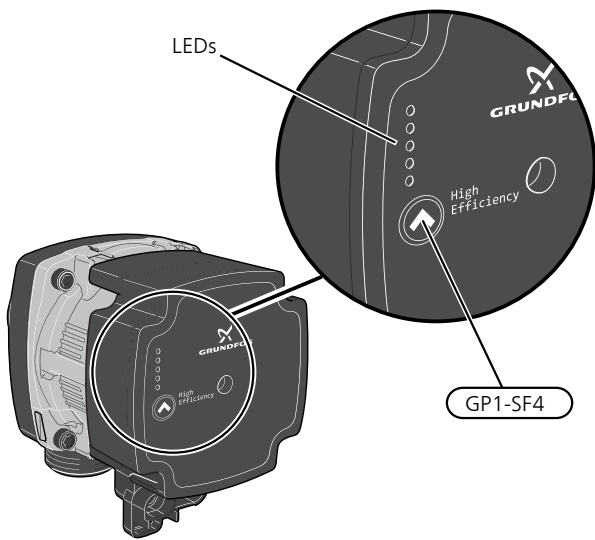

The circulation pump (GP1) is equipped with five LEDs. In normal mode, the LEDs show the power consumption. They can also indicate alarms or be used to display the pump speed.

During normal operation, the LED lights 1 green. The other LEDs light yellow and indicate the pump's power consumption according to the following table.

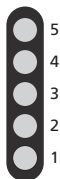

LED indication	Power consumption (% of max power consumption)
Green LED (flashing)	0
Green + one yellow LED	0 – 25
Green + two yellow LEDs	25 – 50
Green + three yellow LEDs	50 – 75
Green + four yellow LEDs	75 – 100

The speed of the circulation pump (GP1) is set using the switch (GP1-SF4) so that the projected flow for the house is achieved. To change the speed, press and hold the switch until the LEDs start to flash. Scroll between the various speeds by pressing the switch.

Choose between 10 different speeds on the pump. There are three different control curves for proportional pressure (PP), or three different constant pressure (CP) and four constant curves (CC).

Press the switch once to see what speed is selected.

To lock/unlock a setting, press and hold the button for 10 seconds.

Pump speed, proportional pressure (PP)

Capacity, circulation pump (PP)

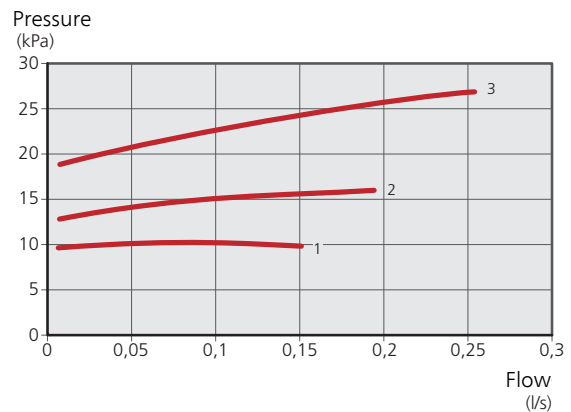

Output, circulation pump (PP)

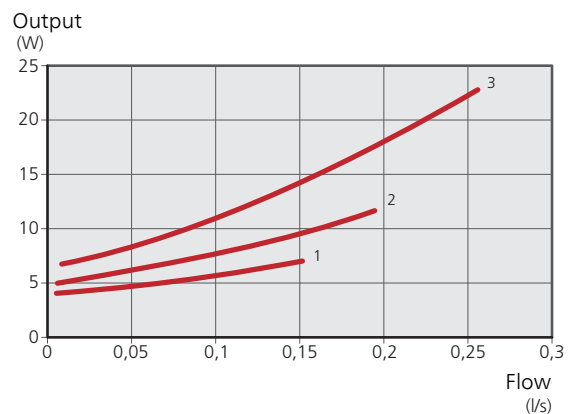

Pump speed (PP)	1	2	3
LED indication			

Pump speed, constant pressure (CP)

Capacity, circulation pump (CP)

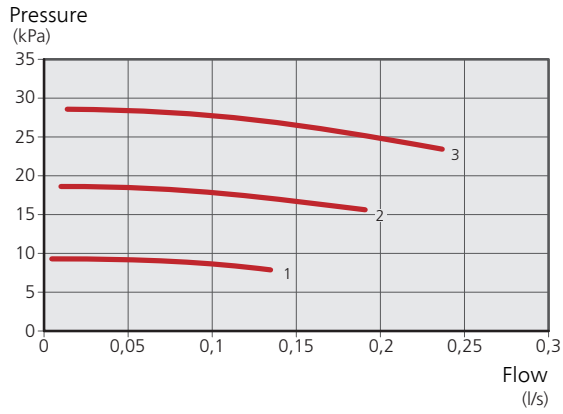

Pump speed, constant curve (CC)

Capacity, circulation pump (CC)

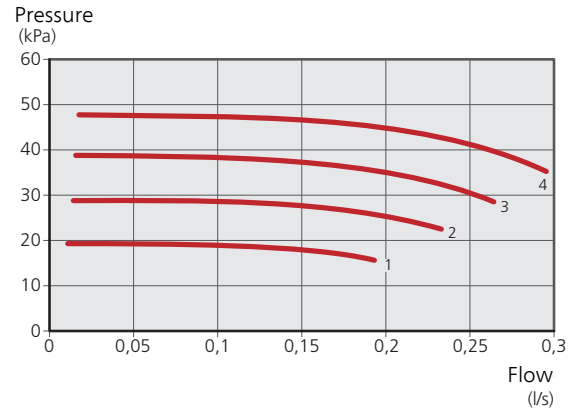

Output, circulation pump (CP)

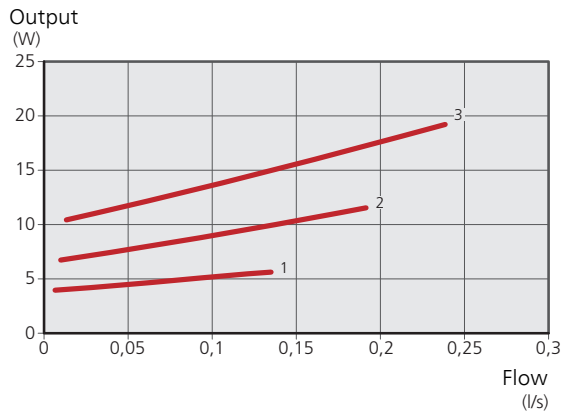

Output, circulation pump (CC)

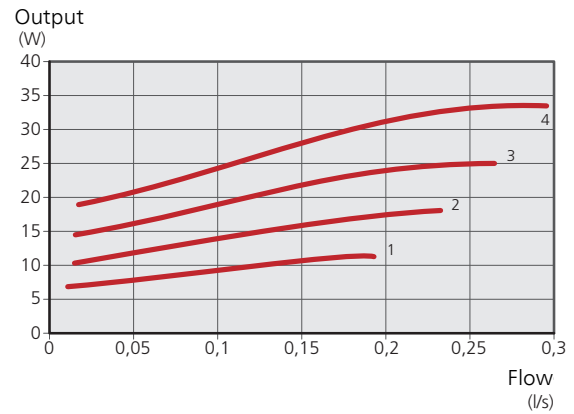

Pump speed (CP)	1	2	3*
LED indication			

Pump speed (CC)	1	2	3	4
LED indication				

*The pump is factory-set with constant pressure (CP) speed 3

Alarm

In the event of an alarm the LED changes 1 colour from green to red. When one or several alarms are active, this is indicated according to the following table. If more than one alarm is active, the one with the highest priority is displayed.

LED indication	Cause / Action
Red + yellow LED (LED 5)	The rotor is blocked. Wait or release the rotor shaft.
Red + yellow LED (LED 4)	Supply voltage too low. Check the supply voltage.
Red + yellow LED (LED 3)	Electrical fault. Check the supply voltage or replace the circulation pump.

Post-adjustment, venting

Air is initially released from the hot water and venting may be necessary. If gurgling sounds can be heard from the heat pump or climate system, the entire system requires additional venting. See section "Venting the climate system" on page 30 for information about venting the heat pump.

Basic values for the curve setting

The values stated on the map apply for the "heating curve" in menu 1.9.1

- The first value applies for low temperature* radiator systems. "temperature" (offset heating curve) in menu 1.1 must be set to -2.
- The value in brackets refers to under floor heating systems** installed in concrete floor structures.
- When the system is installed in a timber floor structure you can use the number before the brackets, but this value must be reduced by two units. "temperature" (offset heating curve) in menu 1.1, set in these cases to -1.



Caution

The map values are usually a good starting point and are intended to provide an approximate room temperature of 20 °C. The values can be adjusted later if necessary.

Examples of basic values selection:

- House with low temperature* radiator systems
London = Area 15 (8).
Set 15 in menu 1.9.1, "heating curve" and -2 in menu 1.1 "temperature" (offset of heating curve).
- House with under floor heating** installed in a concrete floor structure
London = Area 15 (8).
Set 8 in menu 1.9.1, "heating curve" and -2 in menu 1.1 "temperature" (offset of heating curve).
- Houses with under floor heating** installed in a timber floor structure
London = Area 15 (8).
Set 13 (see point three in the list above) in menu 1.9.1, "heating curve" and -1 in menu 1.1 "temperature" (offset of heating curve).



Caution

An increase in the room temperature can be slowed by the thermostats for the radiators or under floor heating. Therefore, open the thermostat valves fully, except in those rooms where a cooler temperature is required, e.g. bedrooms.

* A low-temperature radiator system refers to a system where the supply temperature needs to be 55 °C on the coldest day.

** Under floor heating can be dimensioned very differently. The example above refers to a system where the supply temperature must be approx 35 – 40 °C resp. 45 – 50 °C on the coldest day.

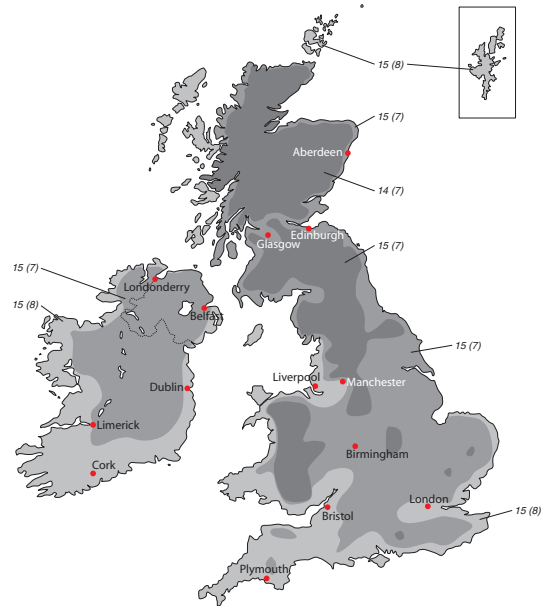

7 Control - Introduction

Display unit

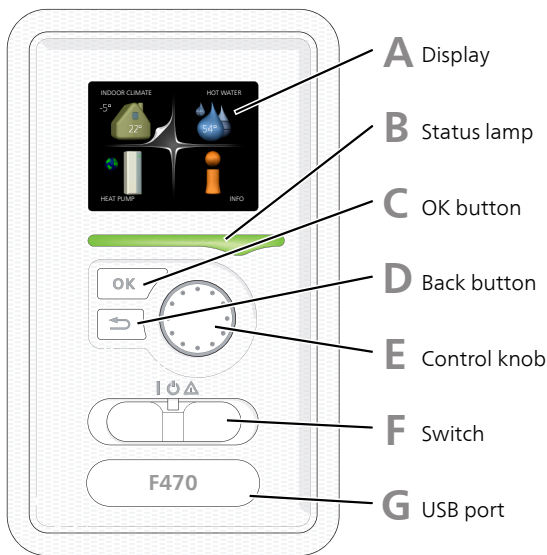

A Display

Instructions, settings and operational information are shown on the display. You can easily navigate between the different menus and options to set the comfort or obtain the information you require.

B Status lamp

The status lamp indicates the status of the heat pump. It:

- lights green during normal operation.
- lights yellow in emergency mode.
- lights red in the event of a deployed alarm.

C OK button

The OK button is used to:

- confirm selections of sub menus/options/set values/page in the start guide.

D Back button

The back button is used to:

- go back to the previous menu.
- change a setting that has not been confirmed.

E Control knob

The control knob can be turned to the right or left. You can:

- scroll in menus and between options.
- increase and decrease the values.
- change page in multiple page instructions (for example help text and service info).

F Switch (SF1)

The switch assumes three positions:

- On (I)
- Standby (⏻)
- Emergency mode (⚠) (see page 49)

Emergency mode must only be used in the event of a fault on the heat pump. In this mode, the compressor and fans switch off and the immersion heater engages. The heat pump display is not illuminated and the status lamp illuminates yellow.

G USB port

The USB port is hidden beneath the plastic badge with the product name on it.

The USB port is used to update the software.

Visit <http://www.nibeuplink.com> and click the "Software" tab to download the latest software for your installation.

Menu system

When the door to the heat pump is opened, the menu system's four main menus are shown in the display as well as certain basic information.

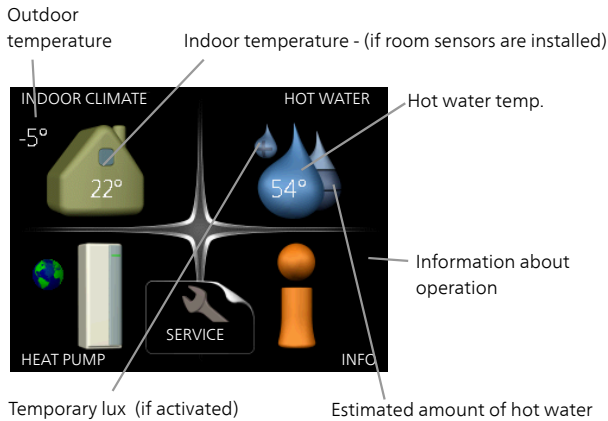

Menu 1 - INDOOR CLIMATE

Setting and scheduling the indoor climate. See information in the help menu or user manual.

Menu 2 - HOT WATER

Setting and scheduling hot water production. See information in the help menu or user manual.

Menu 3 - INFO

Display of temperature and other operating information and access to the alarm log. See information in the help menu or user manual.

Menu 4 - HEAT PUMP

Setting time, date, language, display, operating mode etc. See information in the help menu or user manual.

Menu 5 - SERVICE

Advanced settings. These settings are not available to the end user. The menu is visible when the Back button is pressed for 7 seconds when you are in the start menu. See page 44.

Symbols in the display

The following symbols can appear in the display during operation.

Symbol	Description
	This symbol appears by the information sign if there is information in menu 3.1 that you should note.
	These two symbols indicate whether the compressor or addition is blocked in F470. These can, for example, be blocked depending on which operating mode is selected in menu 4.2, if blocking is scheduled in menu 4.9.5 or if an alarm has occurred that blocks one of them. Blocking the compressor. Blocking additional heat.
	This symbol appears if periodic increase or lux mode for the hot water is activated.
	This symbol indicates whether "holiday setting" is active in 4.7.
	This symbol indicates whether F470 has contact with Uplink.
	This symbol indicates the actual speed of the fan if the speed has changed from the normal setting.
	This symbol indicates whether solar heating is active. Accessory needed.

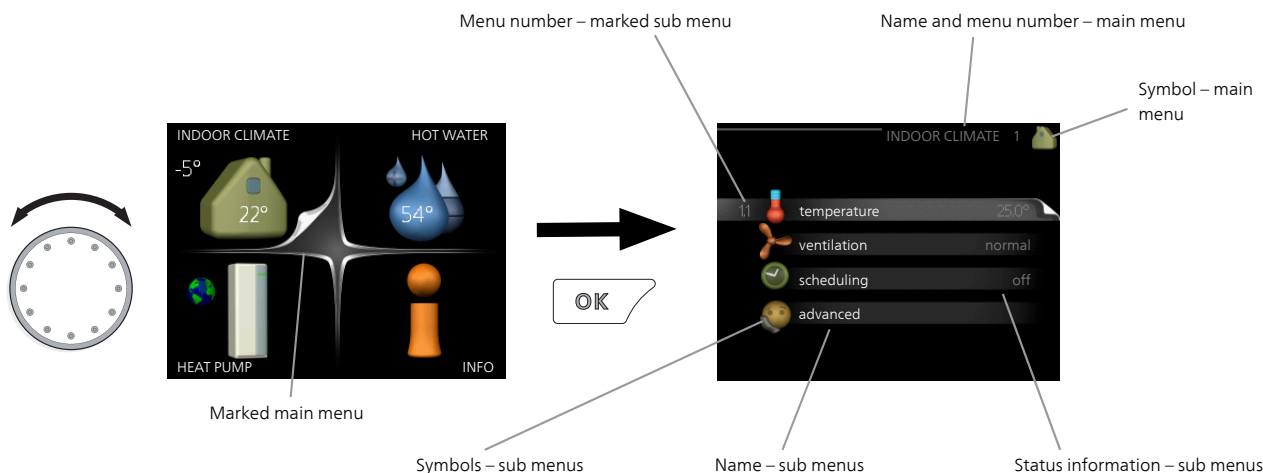

Operation

To move the cursor, turn the control knob to the left or the right. The marked position is white and/or has a turned up tab.



Selecting menu

To advance in the menu system select a main menu by marking it and then pressing the OK button. A new window then opens with sub menus.

Select one of the sub menus by marking it and then pressing the OK button.

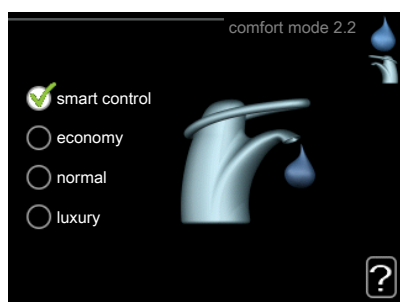

Selecting options



In an options menu the current selected option is indicated by a green tick.



To select another option:





1. Mark the applicable option. One of the options is pre-selected (white). 
2. Press the OK button to confirm the selected option. The selected option has a green tick. 

Setting a value



Values to be changed

To set a value:

1. Mark the value you want to set using the control knob. 
2. Press the OK button. The background of the value becomes green, which means that you have accessed the setting mode. 
3. Turn the control knob to the right to increase the value and to the left to reduce the value. 
4. Press the OK button to confirm the value you have set. To change and return to the original value, press the Back button. 

Use the virtual keyboard

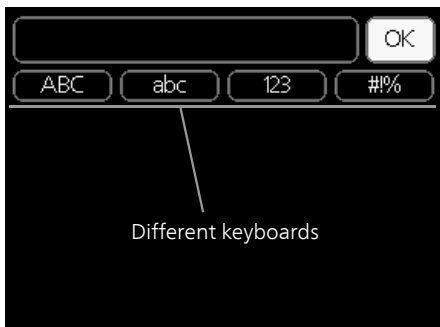

In some menus where text may require entering, a virtual keyboard is available.

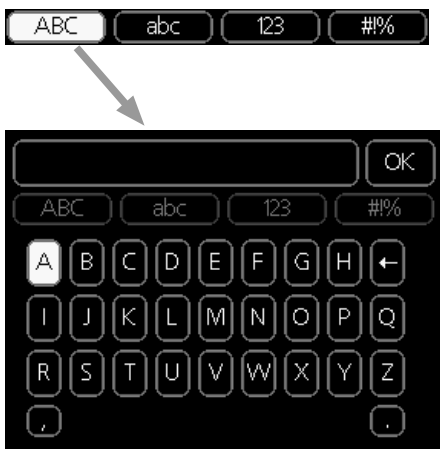

Depending on the menu, you can gain access to different character sets which you can select using the control knob. To change character table, press the Back button. If a menu only has one character set the keyboard is displayed directly.

When you have finished writing, mark "OK" and press the OK button.

Scroll through the windows

A menu can consist of several windows. Turn the control knob to scroll between the windows.



Current menu window Number of windows in the menu

Scroll through the windows in the start guide



Arrows to scroll through window in start guide

1. Turn the control knob until one of the arrows in the top left corner (at the page number) has been marked.
2. Press the OK button to skip between the steps in the start guide.

Help menu



In many menus there is a symbol that indicates that extra help is available.

To access the help text:

1. Use the control knob to select the help symbol.
2. Press the OK button.

The help text often consists of several windows that you can scroll between using the control knob.

8 Control - Menus

Menu 1 - INDOOR CLIMATE

Overview

1 - INDOOR CLIMATE	1.1 - temperature	
	1.2 - ventilation	
	1.3 - scheduling	1.3.1 - heating
		1.3.3 - ventilation
	1.9 - advanced	1.9.1.1 - heating curve
		1.9.2 - external adjustment
		1.9.3 - min. flow line temp.
		1.9.4 - room sensor settings
		1.9.6 - fan return time
		1.9.7 - own curve
	1.9.8 - point offset	
	1.9.9 - night cooling	

Menu 2 - HOT WATER

Overview

2 - HOT WATER	2.1 - temporary lux	
	2.2 - comfort mode	
	2.3 - scheduling	
	2.9 - advanced	2.9.1 - periodic increase
		2.9.2 - hot water recirc. *

* Accessory needed.

Menu 3 - INFO

Overview

3 - INFO	3.1 - service info	
	3.2 - compressor info	
	3.3 - add. heat info	
	3.4 - alarm log	
	3.5 - indoor temp. log	

Menu 4 - HEAT PUMP

Overview

4 - HEAT PUMP	4.1 - plus functions *	4.1.3 - internet	4.1.3.1 - Uplink
			4.1.3.8 - tcp/ip settings
			4.1.3.9 - proxy settings
		4.1.4 - sms *	
		4.1.5 - SG Ready	
		4.1.6 - smart price adaption™	
		4.1.7 - smart home	
		Menu 4.1.10 – solar electricity *	
	4.2 - op. mode		
	4.3 - my icons		
	4.4 - time & date		
	4.6 - language		
	4.7 - holiday setting		
	4.9 - advanced	4.9.2 - auto mode setting	
		4.9.4 - factory setting user	
		4.9.5 - schedule blocking	

* Accessory needed.

Menu 5 - SERVICE

Overview

5 - SERVICE	5.1 - operating settings	5.1.1 - hot water settings
		5.1.2 - max flow line temperature
		5.1.4 - alarm actions
		5.1.5 - fan sp. exhaust air
		5.1.6 - fan sp. supply air
		5.1.12 - internal electrical addition
		5.1.99 - other settings
	5.2 - system settings	5.2.4 - accessories
	5.3 - accessory settings	5.3.3 - extra climate system *
	5.4 - soft in/outputs	
	5.5 - factory setting service	
	5.6 - forced control	
	5.7 - start guide	
	5.8 - quick start	
	5.9 - floor drying function	
	5.10 - change log	
	5.12 - country	

* Accessory needed.

Go to the main menu and hold the Back button in for 7 seconds to access the Service menu.

Sub-menus

Menu **SERVICE** has orange text and is intended for the advanced user. This menu has several sub-menus. Status information for the relevant menu can be found on the display to the right of the menus.

operating settings Operating settings for the heat pump.

system settings System settings for the heat pump, activating accessories etc.

accessory settings Operational settings for different accessories.

soft in/outputs Setting software controlled in and outputs on the input circuit board (AA3).

factory setting service Total reset of all settings (including settings available to the user) to default values.

forced control Forced control of the different components in the heat pump.

start guide Manual start of the start guide which is run the first time the heat pump is started.

quick start Quick starting the compressor.



NOTE

Incorrect settings in the service menus can damage the heat pump.

Menu 5.1 - operating settings

Operating settings can be made for the heat pump in the sub menus.

Menu 5.1.1 - hot water settings

economy

Setting range start temp. economy: 15 - 52 °C

Factory setting start temp. economy: 45 °C

Setting range stop temp. economy: 15 - 55 °C

Factory setting stop temp. economy: 51 °C

normal

Setting range start temp. normal: 15 - 52 °C

Factory setting start temp. normal: 49 °C

Setting range stop temp. normal: 15 - 55 °C

Factory setting stop temp. normal: 55 °C

luxury

Setting range start temp. lux: 15 - 62 °C

Factory setting start temp. lux: 52 °C

Setting range stop temp. lux: 15 - 65 °C

Factory setting stop temp. lux: 58 °C

stop temp. per. increase

Setting range: 55 – 70 °C
Factory setting: 60 °C

Here you set the start and stop temperature of the hot water for the different comfort options in menu 2.2 as well as the stop temperature for periodic increase in menu 2.9.1.

Menu 5.1.2 - max flow line temperature

climate system

Setting range: 20-70 °C
Default value: 60 °C

Set the maximum supply temperature for the climate system here. If the installation has more than one climate system, individual maximum supply temperatures can be set for each system. Climate systems 2 - 8 cannot be set to a higher max supply temperature than climate system 1.



Caution

Underfloor heating systems are normally **max flow line temperature** set between 35 and 45 °C.

Check the max floor temperature with your floor supplier.

Menu 5.1.4 - alarm actions

Select if you want the heat pump to alert you that there is an alarm in the display here.



Caution

If no alarm action is selected, it can result in higher energy consumption in the event of an alarm.

Menu 5.1.5 - fan sp. exhaust air

normal and speed 1-4

Setting range: 0 – 100 %

Set the speed for the five different selectable speeds for the fan here.



Caution

An incorrectly set ventilation flow can damage the house and may also increase energy consumption.

Menu 5.1.6 - fan sp. supply air

normal and speed 1-4

Setting range: 0 – 100 %

Set the speed for the five different selectable speeds for the fan here.



Caution

An incorrectly set value may damage the house in the long term and possibly increase energy consumption.

Menu 5.1.12 - internal electrical addition

set max electrical add.

0 - 8 kW
Default values: 5.3 kW

fuse size

Setting range: 1 - 200 A
Factory setting: 16 A

transformation ratio

Setting range: 300 - 3000
Factory setting: 300

Here you set the max. electrical output of the internal electric additional heat in F470 during normal operation and overcapacity mode (SG Ready), as well as the fuse size and transformer ratio for the installation. The transformer ratio is the factor that is used to convert the metered voltage to current.

Menu 5.1.99 - other settings

trend calculation limit

Setting range: 0 – 20 °C

Default value: 7 °C

transfer time

Setting range: 1 - 60 min

Default value: 15 min

months btwn filter alarms

Setting range: 1 – 12

Default value: 3

Here you can set trend calculation limit, transfer time, months btwn filter alarms and fan synch. operation .

trend calculation limit

Here you set at what outdoor temperature the trend calculation is to be active. Above this limit, connection of the immersion heater is delayed and the immersion heater is not connected if the compressor is able to increase the temperature in the vessel.

transfer time

Here you can set transfer time between heating and hot water production in F470. During the transfer time the compressor maintains the stop temperature that applied during hot water production.

months btwn filter alarms

Here you set the number of months between alarms for a reminder to clean the filters in F470.

fan synch. operation

Select whether the fan is to maintain the same speed, regardless of whether the compressor is operating or not, or alternatively run at different speeds. If the function is activated, fan speed 2 applies when the compressor is not in operation, and normal fan speed applies when the compressor is in operation.

Menu 5.2 - system settings

Make different system settings for the heat pump here, e.g. which accessories are installed.

Menu 5.2.4 - accessories

Inform the heat pump which accessories are installed here.

There are two ways of activating connected accessories. You can either mark the alternative in the list or use the automatic function "search installed acc."

search installed acc.

Mark "search installed acc." and press the OK button to automatically find connected accessories for F470.

Menu 5.3 - accessory settings

The operating settings for accessories that are installed and activated are made in the sub-menus for this.

Menu 5.3.3 - extra climate system

mixing valve amplifier

Setting range: 0.1 – 10.0

Default value: 1.0

mixing valve step delay

Setting range: 10 – 300 s

Default values: 30 s



Caution

This setting option only appears if "passive/active cooling 2-pipe" or "passive cooling 2-pipe" is activated in menu 5.2.4.

The shunt amplification and shunt waiting time for the different extra climate systems that are installed are also set here.

See the accessory installation instructions for function description.

Menu 5.4 - soft in/outputs

Here you can select the input/output on the input board (AA3) to which the external switch function (page 27) is to be connected.

Selectable inputs on terminal block AUX 1-5 (AA3-X6:9-18) and output AA3-X7 on the input board.

Menu 5.5 - factory setting service

All settings can be reset (including settings available to the user) to default values here.



NOTE

When resetting, the start guide is displayed the next time the heat pump is restarted.

Menu 5.6 - forced control

You can force control the different components in the heat pump and any connected accessories here.

Menu 5.7 - start guide

When the heat pump is started for the first time the start guide starts automatically. Start it manually here.

See page 31 for more information about the start guide.

Menu 5.8 - quick start

It is possible to start the compressor from here.



Caution

There must be a heating or hot water demand to start the compressor.



Caution

Do not quick start the compressor too many times over a short period of time as this may damage the compressor and its surrounding equipment.

Menu 5.9 - floor drying function

length of period 1 – 7

Setting range: 0 – 30 days

Factory setting, period 1 – 3, 5 – 7: 2 days

Factory setting, period 4: 3 days

temp. period 1 – 7

Setting range: 15 – 70 °C

Default value:

temp. period 1	20 °C
temp. period 2	30 °C
temp. period 3	40 °C
temp. period 4	45 C
temp. period 5	40 °C
temp. period 6	30 °C
temp. period 7	20 °C

Set the function for under floor drying here.

You can set up to seven period times with different calculated flow temperatures. If less than seven periods are to be used, set the remaining period times to 0 days.

Mark the active window to activate the underfloor drying function. A counter at the bottom shows the number of days the function has been active.



TIP

If operating mode "add. heat only" is to be used, select it in menu 4.2.

Menu 5.10 - change log

Read off any previous changes to the control system here.

The date, time and ID no. (unique to certain settings) and the new set value is shown for every change.



NOTE

The change log is saved at restart and remains unchanged after factory setting.

5.12 - country

Select here where the product was installed. This allows access to country specific settings in your product.

Language settings can be made regardless of this selection.



NOTE

This option locks after 24 hours, restart of display or program updating.

9 Service

NOTE

F470 must be serviced once a year by competent and qualified personnel, such as a NIBE a service engineer or other qualified professional. When replacing components on F470 only replacement parts from NIBE may be used.

NOTE

Take the necessary safety precautions. Ensure that the heat pump is not connected to the power prior to servicing or maintenance work.

NOTE

If an electrical connection has been disconnected and is connected, ground must be checked using a suitable multimeter.

NOTE

An immersion heater without a temperature limiter is not allowed to be installed.

NOTE

Inspection of the water heater can be carried out via the flange located at the top of the water heater using an inspection instrument such as an endoscope.

NOTE

After servicing, complete the relevant Service Interval Record section of the Benchmark Checklist located at the back of this document. Completion of the Service Interval Record is a condition of warranty. For full terms and conditions of warranty, please see our website www.nibe.co.uk.

Maintenance

Cleaning the overflow cup/floor drain

Regularly check that the overflow cup and any floor drains are not blocked; water must be able to run through freely. Clean, if necessary.

NOTE

If the overflow cup or floor drain is blocked, water can run over onto the floor of the installation area. To prevent damage to the building the floor coating must be considered. A waterproof floor or floor membrane is recommended.

General inspection

Check the following:

1. Condition of casing.
2. Electrical connections.
3. Pipe connections.
4. Alarm log.

Correct any fault before continuing.

Water heater

Check the following:

1. Hot water start and stop temperature.
2. Pressure controlled bypass valve.
3. T&P valve.
4. Overflow pipe.
5. Pressure expansion vessel.

Correct any fault before continuing.

Hot water settings

Check the following:

1. Hot water start and stop temperature.
2. Hot water mode.

Correct any fault before continuing.

Climate system

Check the following:

1. Climate system start and stop temperature.
2. Heating curve settings.
3. Function of the room sensor (if installed).
4. Limiting valve settings.
5. System pressure.
6. Flow and return temperature. The difference must be 5 - 10 °C

Correct any fault before continuing.

Ventilation system

Check the following:

1. The air filter. Clean or replace if necessary.
2. Any dirt on the fan. Clean if necessary.
3. Ensure that the ventilation openings are not blocked.
4. The airflow. Adjust if necessary.
5. Ensure that the damper motor is not blocked.

Correct any fault before continuing.

Safety valves

F470 has three safety valves, two for the water heater and one for the climate system.

The function of the safety valves must be checked regularly. The valves are accessed via the service hatch. Perform checks as follows:

1. Open the valve by turning the knob anti-clockwise carefully.
2. Check that water flows through the valve.
3. Close the valve by releasing it. If it does not close automatically when released, turn it anti-clockwise slightly.
4. The climate system may need to be refilled after checking the safety valve, see the section "Filling the climate system".

Service actions

Emergency mode

Emergency mode is used in event of operational interference and in conjunction with service.

Emergency mode is activated by setting switch (SF1) in mode "▲". This means that:

- The status lamp illuminates yellow.
- The display is not lit and the control computer is not connected.
- The temperature in the heating section is controlled by a fixed thermostat (BT30) at 63°C.
- The compressor and the fans are off and only the heating medium pump and the electric additional heat are active. The additional heat power in emergency mode is set in the immersion heater board (AA1). See page 26 for instructions.
- The automatic heating control system is not operational, so manual shunt operation is required. This is done by turning the adjustment screw on the shunt motor (MA1) to "manual mode" and then turning the shunt lever to the desired position.

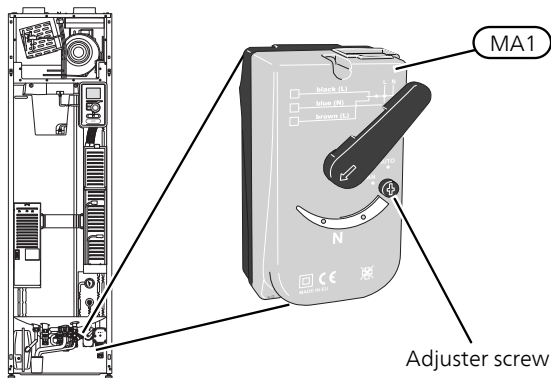

Draining the water heater

The water heater can be drained via the safety valve (FL1) or via the overflow cup (WM1).

1. Disconnect the overflow pipe from the safety valve (FL1) and connect a hose to a draining pump instead. If a draining pump is not available, the water can be released into the overflow cup (WM1).
2. Open the safety valve (FL1).
3. Open a hot water tap to let air into the system. If this is not sufficient, detach the pipe connection (XL4) on the hot water side and ensure that air is entering.

Cleaning the water heater

To clean the water heater, remove the upper panel and the insulation. Then open the flange for easy access.

Draining the climate system

In order to carry out service on the climate system, it may be easier to drain the system first.



NOTE

There may be some hot water when draining the heating medium side/climate system. There is a risk of scalding.

The hot water can be drained through the safety valve (FL2) via the overflow cup (WM1) or through a hose that is connected to the safety valve's (FL2) outlet.

1. Open the safety valve (FL2).
2. Set the vent valve for the climate system (QM20) in the open position for air supply.

Helping the circulation pump to start

The circulation pump in F470 has an automatic start help function. If necessary the pump can be started manually. In such cases, take the following action:

1. Shut off F470 by setting the switch (SF1) to mode "0".
2. Remove the front hatch.
3. Press the screw for start help in using a star head screwdriver as illustrated.
4. With the screw pressed in, turn the screwdriver in any direction.
5. Start F470 by setting the switch (SF1) to mode "I" and check that the circulation pump functions.

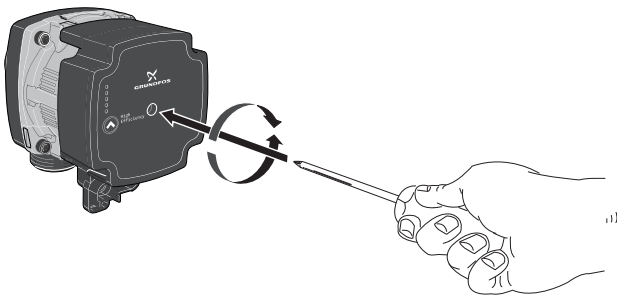

Temperature sensor data

Temperature (°C)	Resistance (kOhm)	Voltage (VDC)
-40	351.0	3.256
-35	251.6	3.240
-30	182.5	3.218
-25	133.8	3.189
-20	99.22	3.150
-15	74.32	3.105
-10	56.20	3.047
-5	42.89	2.976
0	33.02	2.889
5	25.61	2.789
10	20.02	2.673
15	15.77	2.541
20	12.51	2.399
25	10.00	2.245
30	8.045	2.083
35	6.514	1.916
40	5.306	1.752
45	4.348	1.587
50	3.583	1.426
55	2.968	1.278
60	2.467	1.136
65	2.068	1.007
70	1.739	0.891
75	1.469	0.785
80	1.246	0.691
85	1.061	0.607
90	0.908	0.533
95	0.779	0.469
100	0.672	0.414

USB service outlet

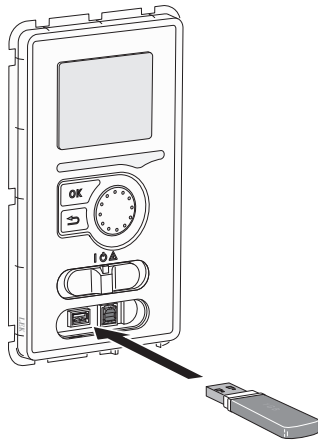

The display unit is equipped with a USB socket that can be used to update the software, save logged information and handle the settings in F470.

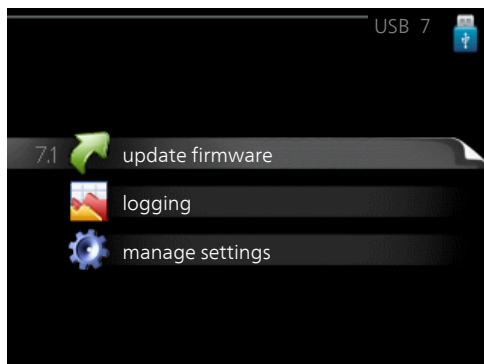
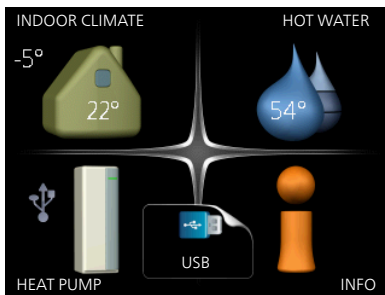

When a USB memory is connected a new menu (menu 7) appears in the display.

Menu 7.1 - update firmware

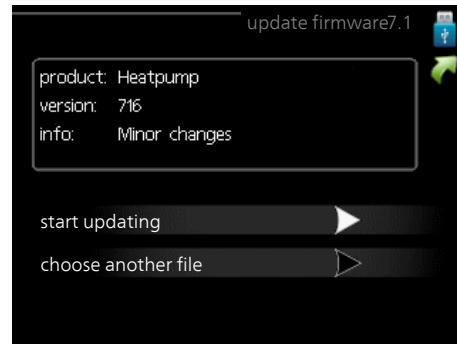

This allows you to update the software in F470.



NOTE

For the following functions to work the USB memory must contain files with software for F470 from NIBE.

The fact box at the top of the display shows information (always in English) of the most probable update that the update software has selected from the USB memory.

This information states which product the software is intended for, the software version and general information about them. If you wish to select another file than the one selected, the correct file can be selected by "choose another file".

start updating

Select "start updating" if you want to start the update. You are asked whether you really want to update the software. Respond "yes" to continue or "no" to undo.

If you responded "yes" to the previous question the update starts and you can now follow the progress of the update on the display. When the update is complete F470 restarts.



NOTE

A software update does not reset the menu settings in F470.



NOTE

If the update is interrupted before it is complete (for example power cut etc.), the software can be reset to the previous version if the OK button is held in during start up until the green lamp starts to illuminate (takes about 10 seconds).

choose another file



Select "choose another file" if you do not want to use the suggested software. When you scroll through the files, information about the marked software is shown in a fact box just as before. When you have selected a file with the OK button you will return to the previous page (menu 7.1) where you can choose to start the update.

Menu 7.2 - logging

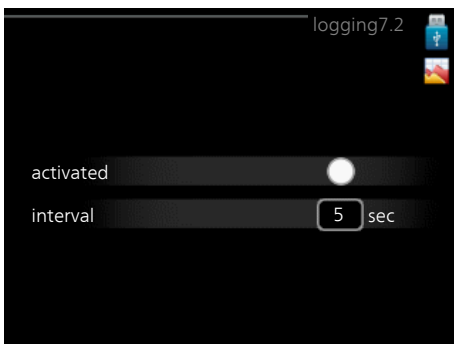

Setting range: 1 s – 60 min
Factory setting range: 5 s

Here you can choose how current measurement values from F470 should be saved onto a log file on the USB memory.

1. Set the desired interval between loggings.
2. Tick "activated".
3. The present values from F470 are saved in a file in the USB memory at the set interval until "activated" is unticked.

NOTE
Untick "activated" before removing the USB memory.

Menu 7.3 - manage settings

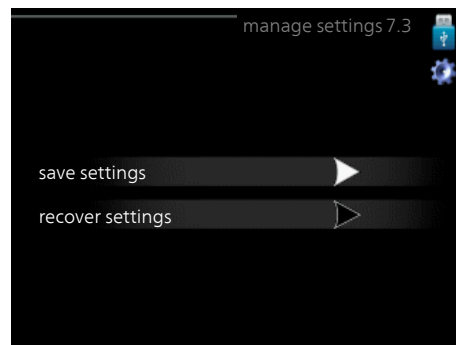

Here you can manage (save as or retrieve from) all the menu settings (user and service menus) in F470 with a USB memory.

Via "save settings" you save the menu settings to the USB memory in order to restore them later or to copy the settings to another F470.

NOTE
When you save the menu settings to the USB memory you replace any previously saved settings on the USB memory.

Via "recover settings" you reset all menu settings from the USB memory.

NOTE
Reset of the menu settings from the USB memory cannot be undone.

10 Disturbances in comfort

In most cases, the heat pump notes operational interference (operational interference can lead to disturbance in comfort) and indicates this with alarms and shows action instructions in the display.

Info-menu

All the heat pump measurement values are gathered under menu 3.1 in the heat pump menu system. Looking through the values in this menu can often simplify finding the source of the fault. See help menu or user manual for more information about menu 3.1.

Manage alarm

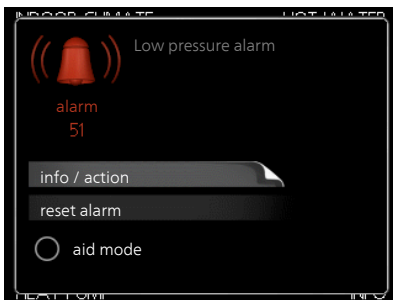

In the event of an alarm, some kind of malfunction has occurred, which is indicated by the status lamp changing from green continuously to red continuously. In addition, an alarm bell appears in the information window.

Alarm

In the event of an alarm with a red status lamp a malfunction has occurred that the heat pump cannot remedy itself. In the display, by turning the control knob and pressing the OK button, you can see the type of alarm it is and reset it. You can also choose to set the heat pump to aid mode.

info / action Here you can read what the alarm means and receive tips on what you can do to correct the problem that caused the alarm.

reset alarm In most cases it is enough to select "reset alarm" to correct the problem that caused the alarm. If a green light illuminates after selecting "reset alarm" the alarm has been remedied. If a red light is still visible and a menu called "alarm" is visible in the display, the problem that caused the alarm remains. If the alarm disappears and then returns, see the section "Troubleshooting".

aid mode "aid mode" is a type of emergency mode. This means that the heat pump produces heat and/or hot water despite there being some kind of problem. This can mean that the heat pump's compressor is not running. In this case the immersion heater produces heat and/or hot water.



NOTE

To select aid mode an alarm action must be selected in the menu 5.1.4.



Caution

Selecting "aid mode" is not the same as correcting the problem that caused the alarm. The status lamp will therefore continue to be red.

Troubleshooting

If the operational interference is not shown in the display the following tips can be used:

Basic actions

Start by checking the following possible fault sources:

- The switch's (SF1) position.
- Group and main fuses of the accommodation.
- Earth-fault breaker.
- The heat pump's miniature circuit breaker (FA1).
- The heat pump's temperature limiter (FD1).

Low hot water temperature or a lack of hot water

- Closed or throttled externally mounted filler valve for the water heater.
 - Open the valve.
- Heat pump in incorrect operating mode.
 - Enter menu 4.2. If mode "auto" is selected, select a higher value on "stop additional heat" in menu 4.9.2.
 - If mode "manual" is selected, select "addition".
- Large hot water consumption.
 - Wait until the hot water has heated up. Temporarily increased hot water capacity (temporary lux) can be activated in menu 2.1.
- Too low hot water setting.
 - Enter menu 2.2 and select a higher comfort mode.

Low room temperature

- Closed thermostats in several rooms.
 - See the "Saving tips" section in the User manual for more detailed information about how to best set the thermostats.
- Heat pump in incorrect operating mode.
 - Enter menu 4.2. If mode "auto" is selected, select a higher value on "stop heating" in menu 4.9.2.
 - If mode "manual" is selected, select "heating". If this is not enough, select "addition".
- Too low set value on the automatic heating control.
 - Enter menu 1.1 "temperature" and adjust the offset heating curve up. If the room temperature is only low in cold weather the curve slope in menu 1.9.1 "heating curve" needs adjusting up.
- "comfort mode" "luxury" selected in combination with large hot water outlet.
 - Enter menu 2.2 and select "economy" or "normal".

- "Holiday mode" activated in menu 4.7.
 - Enter menu 4.7 and select "Off".
- External switch for changing the room heating activated.
 - Check any external switches.
- The heating medium pump (GP1) has stopped.
 - See section "Helping the circulation pump to start" on page 50.
- Air in the heating system.
 - Vent the heating system (see page 30).
- Closed valves (QM31), (QM32) to the heating system.
 - Open the valves.

High room temperature

- Too high set value on the automatic heating control.
 - Enter menu 1.1 (temperature) and reduce the offset heating curve. If the room temperature is only high in cold weather the curve slope in menu 1.9.1 "heating curve" needs adjusting down.
- External switch for changing the room heating activated.
 - Check any external switches.
- Trim valve to supply air coil (RN1) is not adjusted.
 - Adjust the valve (see diagram on page 33).

Low system pressure

- Not enough water in the heating system.
 - Top up the water in the heating system (see page 30).

Low or a lack of ventilation

- Filter (HQ10/HQ11) blocked.
 - Clean or replace the filter.
- The ventilation is not adjusted.
 - Order/implement ventilation adjustment.
- Exhaust air device blocked or throttled down too much.
 - Check and clean the exhaust air devices.
- Fan speed in reduced mode.
 - Enter menu 1.2 and select "normal".
- External switch for changing the fan speed activated.
 - Check any external switches.

High or distracting ventilation

- Filter (HQ10) blocked.
 - Clean or replace the filter.
- The ventilation is not adjusted.
 - Order/implement ventilation adjustment.
- Fan speed in forced mode.
 - Enter menu 1.2 and select "normal".
- External switch for changing the fan speed activated.
 - Check any external switches.

Low supply air temperature

- Air in the supply air battery
 - Bleed the supply air battery.
- Trim valve too restricted (RN1)
 - Adjust the trim valve (see diagram on page 33).

High supply air temperature

- Trim valve (RN1) not sufficiently restricted.
 - Adjust the trim valve (see diagram on page 33).

The compressor does not start

- There is no heating requirement.
 - The heat pump does not call on heating nor hot water.
 - The heat pump defrosts.
- Compressor blocked due to the temperature conditions.
 - Wait until the temperature is within the product's working range.
- Minimum time between compressor starts has not been reached.
 - Wait 30 minutes and then check if the compressor has started.
- Alarm tripped.
 - Follow the display instructions.

11 Accessories

Blocking of supply air heating BSA 10

BSA 10 used to block supply air heating in F470 at the same time as some heat production is required in all or parts of the waterborne heating system.

Part no. 067 601

Communications module SMS 40

When there is no internet connection, you can use the accessory SMS 40 to control F470 via SMS.

Part no 067 073

Docking kit DEH

There are separate docking kits available for connecting other heat sources to the heat pump.

Docking kit wood/oil/pellets DEH 40

Part no. 066 101

Docking kit gas DEH 41

Part no. 066 102

Docking kit Solar 41

Solar 41 means that F470 together with e.g. NIBE UKVS 230 can be connected to thermal solar heating.

Part no. 067 127

Extra shunt group ECS 40/ECS 41

This accessory is used when F470 is installed in houses with two or more different heating systems that require different supply temperatures.

ECS 40 (Max 80 m²)

Part no 067 287

ECS 41 (approx. 80-250 m²)

Part no 067 288

Room unit RMU 40

RMU 40 means that control and monitoring of F470 can be carried out in a different part of your home to where it is located.

Part no 067 064

Top cabinet

Top cabinet that conceals the ventilation ducts.

Height 245 mm

Part no. 067 517

Height 385-635 mm

Part no. 067 519

Height 345 mm

Part no. 067 518

12 Technical data

Dimensions and setting-out coordinates

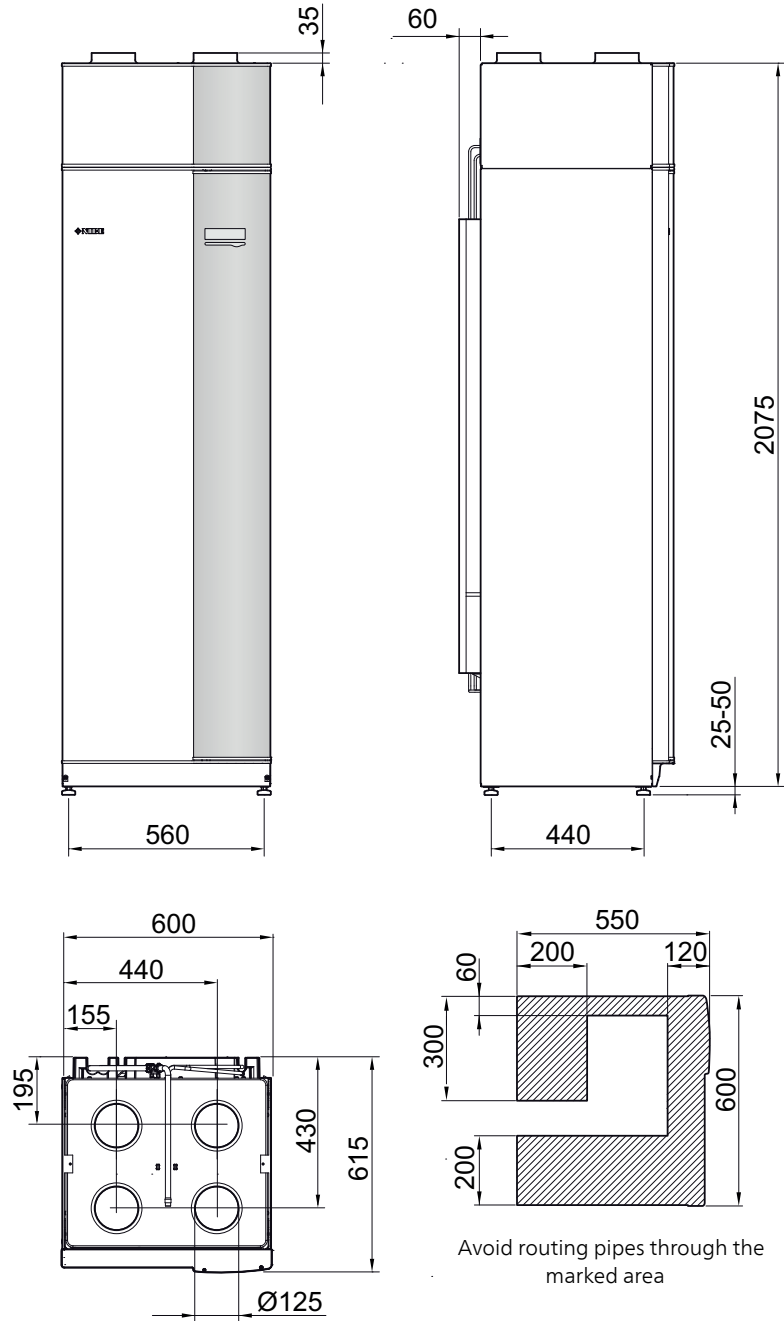

Technical specifications



1x230 V		Stainless
<i>Output data according to EN 14 511</i>		
Specified heating output (P _H) ¹	kW	2.18
COP ¹		3.93
Specified heating output (P _H) ²	kW	2.03
COP ²		3.24
Specified heating output (P _H) ³	kW	1.88
COP ³		2.74
<i>Output data according to EN 14 825</i>		
Rated heat output (P _{designh})	kW	3
SCOP cold climate, 35 °C / 55 °C	kW	3.70 / 3.08
SCOP average climate, 35 °C / 55 °C	kW	3.58 / 2.98
SCOP warm climate, 35 °C / 55 °C	kW	3.58 / 2.98
<i>Additional power</i>		
Max power, immersion heater (factory setting)	kW	8.0 (5.3)
<i>Electrical data</i>		
Rated voltage	V	230 V ~ 50 Hz
Max operating current	A	41
Min. fuse rating	A	10
Drive output heating medium pump	W	4-34
Driving power exhaust air fan	W	25-140
Driving power supply air fan	W	25-140
Enclosure class		IP 21
<i>Refrigerant circuit</i>		
Type of refrigerant		R290, propane
Volume	kg	0.44
Cut-out value pressostat HP	MPa/bar	2.45 / 24.5
Cut-out value pressostat LP	MPa/bar	0.15 / 1.5
<i>Heating medium circuit</i>		
Opening pressure, safety valve	MPa/bar	0.25 / 2.5
Operating pressure (supply line)	MPa/bar	0.2 / 2.0
Max temperature, supply line (factory setting)	°C	70 (60)
<i>Ventilation</i>		
Min. air flow at exhaust air temperature at least 20°C	l/s	28
Min. air flow at exhaust air temperature below 20°C	l/s	31
<i>Sound effect level according to EN 12 102</i>		
Sound power level (L _{W(A)}) ⁴	dB(A)	51.5-54.5
<i>Sound pressure levels</i>		
Sound pressure level in the boiler room (L _{P(A)}) ⁵	dB(A)	47.5-50.5
<i>Pipe connections</i>		
Heating medium ext Ø	mm	22
Hot water ext Ø	mm	22
Cold water ext Ø	mm	22
Ventilation Ø	mm	125

Other 1x230 V		Stainless
<i>Water heater and heating section</i>		
Volume heating section	litre	70
Volume, hot water heater	litre	170
Max pressure in hot water heater	MPa/bar	1.0 / 10.0
<i>Capacity, hot water</i>		
Tap volume 40 °C according to EN 16 147 (V _{max}) ^{6,7}	litre	281
COP at Normal comfort (COP _c)		1.97
Idle loss at Normal comfort (P _{es})	W	54
Maximum water supply pressure	MPa/bar	1.6 / 16
Operating pressure, tap water	MPa/bar	0.6 / 6.0
Expansion vessel, tap water, precharge pressure	MPa/bar	0.35 / 3.5
Volume expansion vessel (external)	litre	18
Pressure reduction valve, setting	MPa/bar	0.3 / 3.0
Max operating pressure of T&P-valve	MPa/bar	0.7 / 7.0
Max operating temperature T&P-valve	°C	95
Discharge capacity of T&P-valve	kW	25
Set opening pressure expansion valve tap water	MPa/bar	0.6 / 6.0
Cut out, temperature limiter	°C	80
Heating time 15 °C to 60 °C	h min	1:26
Reheating time to 60°C, 70% of total volume	min.	57
<i>Dimensions and weight</i>		
Width	mm	600
Depth	mm	616
Height incl. feet		2,100 - 2,125
Required ceiling height	mm	2,270
Net weight	kg	207
Mass unit, filled with water	kg	447
Part No.		066 053

¹A20(12)W35, exhaust air flow 56 l/s (200 m³/h)

²A20(12)W45, exhaust air flow 42 l/s (150 m³/h)

³A20(12)W55, exhaust air flow 31 l/s (110 m³/h)

⁴The value varies with the selected fan curve. For more extensive sound data including sound to channels visit nibe.eu.

⁵ The value can vary with the room's damping capacity. These values apply at a damping of 4 dB.

⁶A20(12) exhaust air flow 42 l/s (150 m³/h)

⁷Comfort mode, normal

Energy labelling

Information sheet

Supplier		NIBE
Model		F470
Temperature application	°C	35 / 55
Declared load profile for water heating		L
Seasonal space heating energy efficiency class, average climate		A+ / A+
Water heating energy efficiency class, average climate		A
Rated heat output ($P_{designh}$), average climate	kW	3 / 3
Annual energy consumption space heating, average climate	kWh	1505 / 1806
Annual energy consumption water heating, average climate	kWh	1299
Seasonal space heating energy efficiency, average climate	%	140 / 116
Water heating energy efficiency, average climate	%	79
Sound power level L_{WA} indoors	dB	52
Rated heat output ($P_{designh}$), cold climate	kW	3 / 3
Rated heat output ($P_{designh}$), warm climate	kW	3 / 3
Annual energy consumption space heating, cold climate	kWh	1737 / 2091
Annual energy consumption water heating, cold climate	kWh	1299
Annual energy consumption space heating, warm climate	kWh	973 / 1168
Annual energy consumption water heating, warm climate	kWh	1299
Seasonal space heating energy efficiency, cold climate	%	145 / 120
Water heating energy efficiency, cold climate	%	79
Seasonal space heating energy efficiency, warm climate	%	140 / 116
Water heating energy efficiency, warm climate	%	79
Sound power level L_{WA} outdoors	dB	-

Data for energy efficiency of the package

Model		F470
Temperature application	°C	35 / 55
Controller, class		VII
Controller, contribution to efficiency	%	3,5
Seasonal space heating energy efficiency of the package, average climate	%	143 / 119
Seasonal space heating energy efficiency class of the package, average climate		A+ / A+
Seasonal space heating energy efficiency of the package, cold climate	%	148 / 123
Seasonal space heating energy efficiency of the package, warm climate	%	143 / 119

The reported efficiency of the package also takes the controller into account. If an external supplementary boiler or solar heating is added to the package, the overall efficiency of the package should be recalculated.

Technical documentation

Model				F470							
Type of heat pump				<input type="checkbox"/> Air-water <input checked="" type="checkbox"/> Exhaust-water <input type="checkbox"/> Brine-water <input type="checkbox"/> Water-water							
Low-temperature heat pump				<input type="checkbox"/> Yes <input checked="" type="checkbox"/> No							
Integrated immersion heater for additional heat				<input checked="" type="checkbox"/> Yes <input type="checkbox"/> No							
Heat pump combination heater				<input checked="" type="checkbox"/> Yes <input type="checkbox"/> No							
Climate				<input checked="" type="checkbox"/> Average <input type="checkbox"/> Cold <input type="checkbox"/> Warm							
Temperature application				<input checked="" type="checkbox"/> Average (55 °C) <input type="checkbox"/> Low (35 °C)							
Applied standards				EN14825, EN16147							
Rated heat output		Prated	2,6	kW	Seasonal space heating energy efficiency		η_s	116	%		
<i>Declared capacity for space heating at part load and at outdoor temperature T_j</i>				<i>Declared coefficient of performance for space heating at part load and at outdoor temperature T_j</i>							
$T_j = -7\text{ °C}$	Pdh	1.7	kW	$T_j = -7\text{ °C}$	COPd	2.72	-				
$T_j = +2\text{ °C}$	Pdh	1.7	kW	$T_j = +2\text{ °C}$	COPd	3.22	-				
$T_j = +7\text{ °C}$	Pdh	1.7	kW	$T_j = +7\text{ °C}$	COPd	3.37	-				
$T_j = +12\text{ °C}$	Pdh	1.7	kW	$T_j = +12\text{ °C}$	COPd	3.28	-				
$T_j = \text{biv}$	Pdh	1.7	kW	$T_j = \text{biv}$	COPd	3.04	-				
$T_j = \text{TOL}$	Pdh	1.7	kW	$T_j = \text{TOL}$	COPd	2.56	-				
$T_j = -15\text{ °C}$ (if TOL < -20 °C)	Pdh		kW	$T_j = -15\text{ °C}$ (if TOL < -20 °C)	COPd		-				
Bivalent temperature				T_{biv}	-1.6	°C	Min. outdoor air temperature		TOL	-10	°C
Cycling interval capacity				P _{cy}		kW	Cycling interval efficiency		COP _{cy}		-
Degradation coefficient				C _{dh}	0.96	-	Max supply temperature		WTOL	58	°C
<i>Power consumption in modes other than active mode</i>				<i>Additional heat</i>							
Off mode		P _{OFF}	0.002	kW	Rated heat output		P _{sup}	0.9	kW		
Thermostat-off mode		P _{TO}	0.02	kW	Type of energy input		Electric				
Standby mode		P _{SB}	0.015	kW							
Crankcase heater mode		P _{CK}	0	kW							
<i>Other items</i>											
Capacity control		Fixed			Rated airflow (air-water)			150	m ³ /h		
Sound power level, indoors/outdoors		L _{WA}	52 / -	dB	Nominal heating medium flow			0.18	m ³ /h		
Annual energy consumption		Q _{HE}	1,806	kWh	Brine flow brine-water or water-water heat pumps				m ³ /h		
<i>For heat pump combination heater</i>											
Declared load profile for water heating				L		Water heating energy efficiency		η_{wh}	79	%	
Daily energy consumption		Q _{elec}	5.92	kWh	Daily fuel consumption		Q _{fuel}		kWh		
Annual energy consumption		AEC	1,299	kWh	Annual fuel consumption		AFC		GJ		
Contact information		NIBE Energy Systems – Box 14 – Hannabadsvägen 5 – 285 21 Markaryd – Sweden									

Electrical circuit diagram

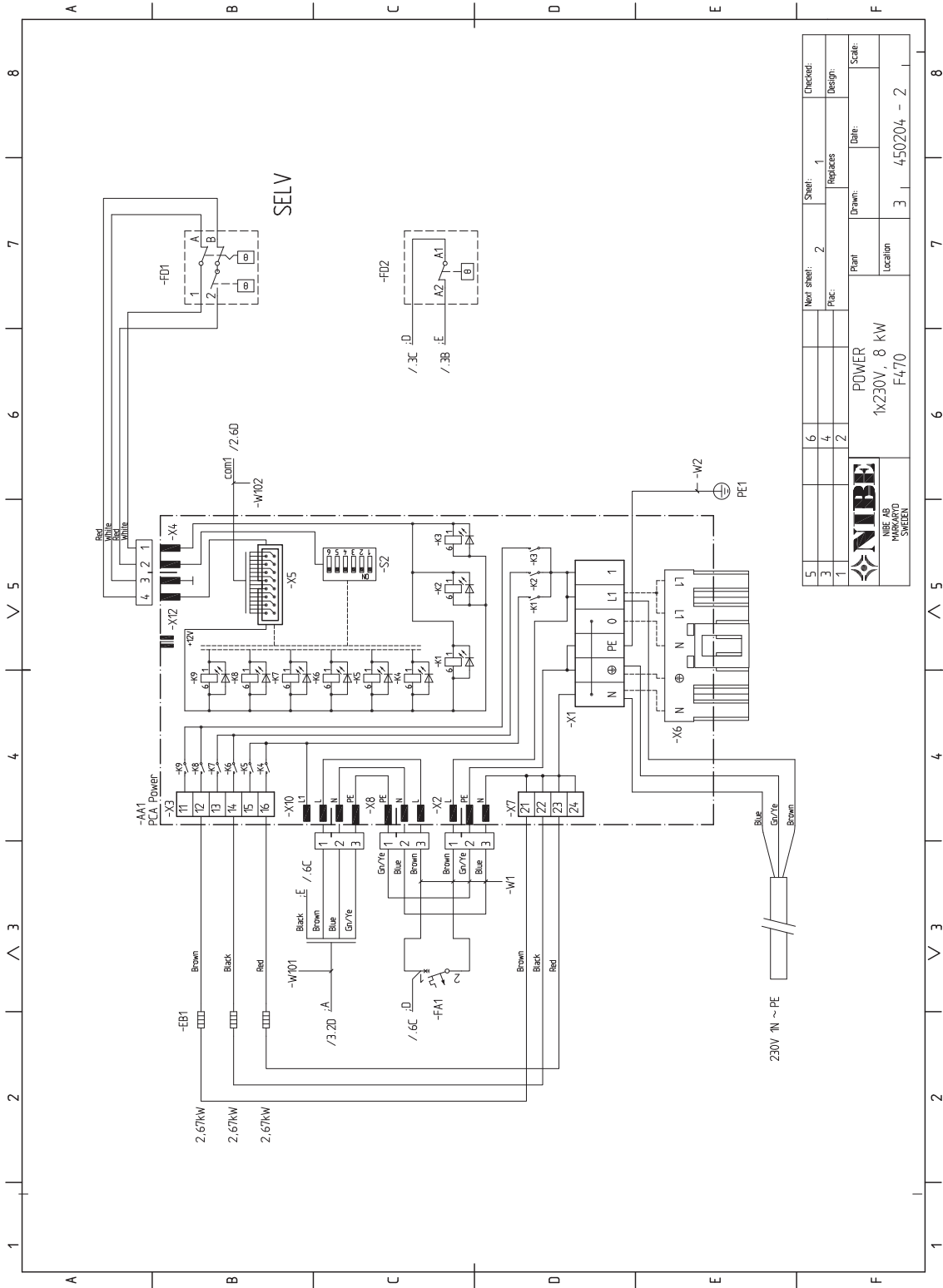

5	6	Next sheet:	1	Checked:
3	4	Fac:	Replaces	Design:
1	2	Part:	Drawn:	Date:
		POWER	Location	Scale:
		1x230V 8 kW	3	450204 - 2
		F470		
NIBE NIBE AB SWEDEN				

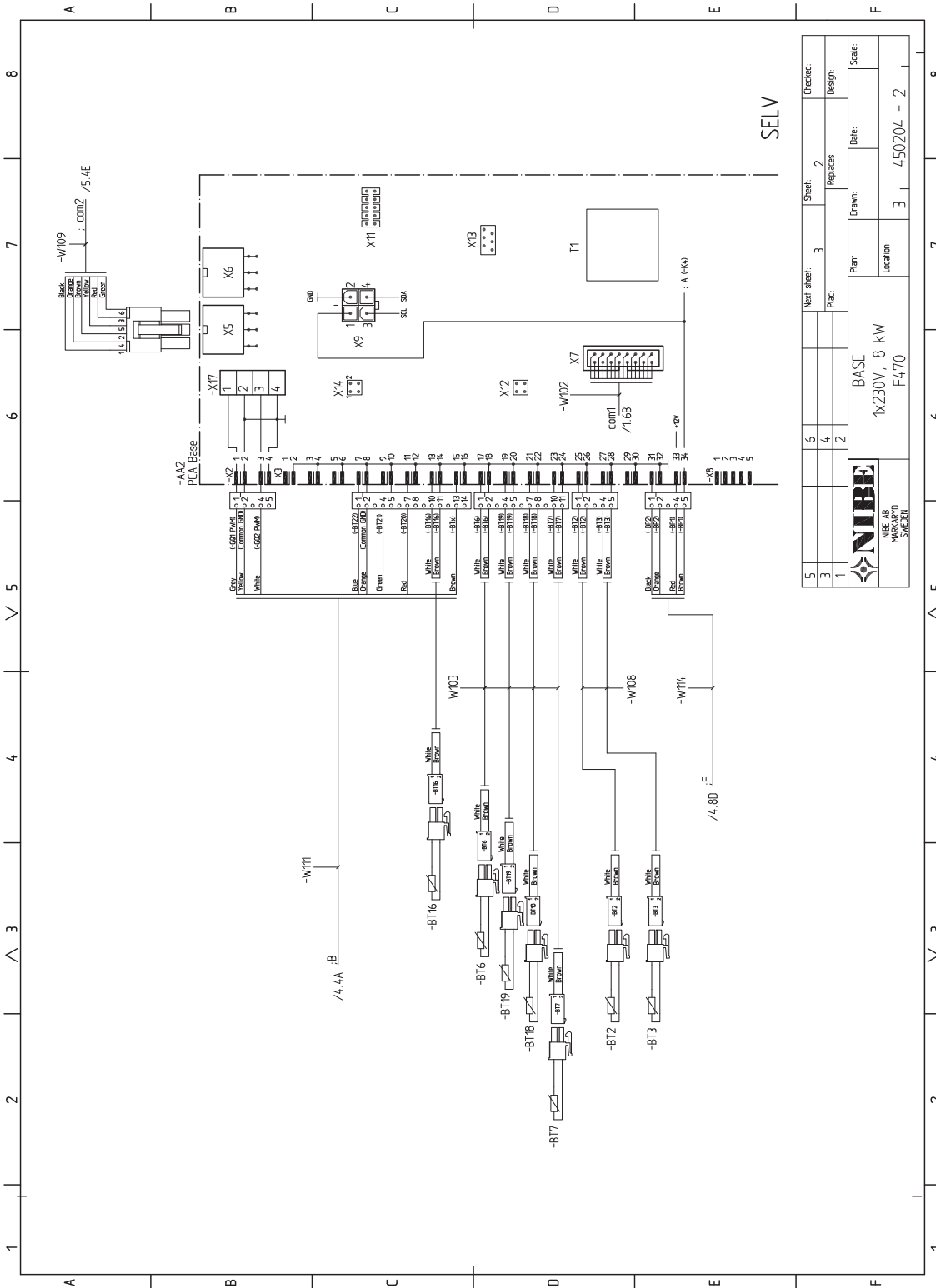

SELV

5	6	Next sheet:	3	Sheet:	2	Checked:
3	4	Plac:	2	Replaces		Design:
1	2	Drawn:		Plant		Date:
 NIBE NIBE AB MUSELÅRD SWEDEN			BASE 1x230V, 8 kW F4,70		Location 3 450204 - 2	
			Scale:			

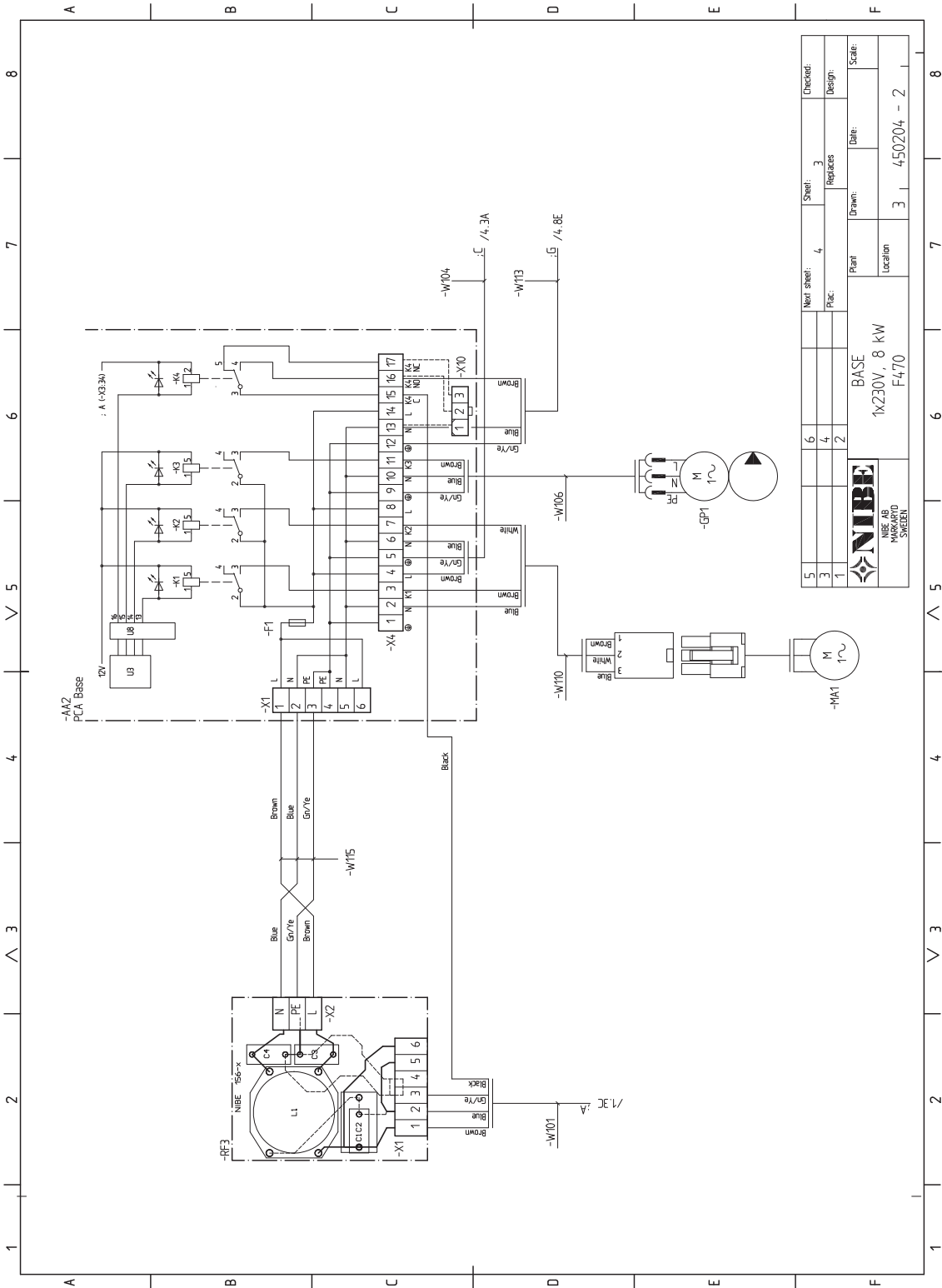

5	Next sheet:	4	Sheet:	3	Checked:
3	Fig:		Replaces		Design:
1			Plant		Date:
			Location		Scale:
NIBE NIBE AB MÖRBYLINDEN SWEDEN					
BASE 1x230V, 8 kW F4,70					
			3	450204 - 2	

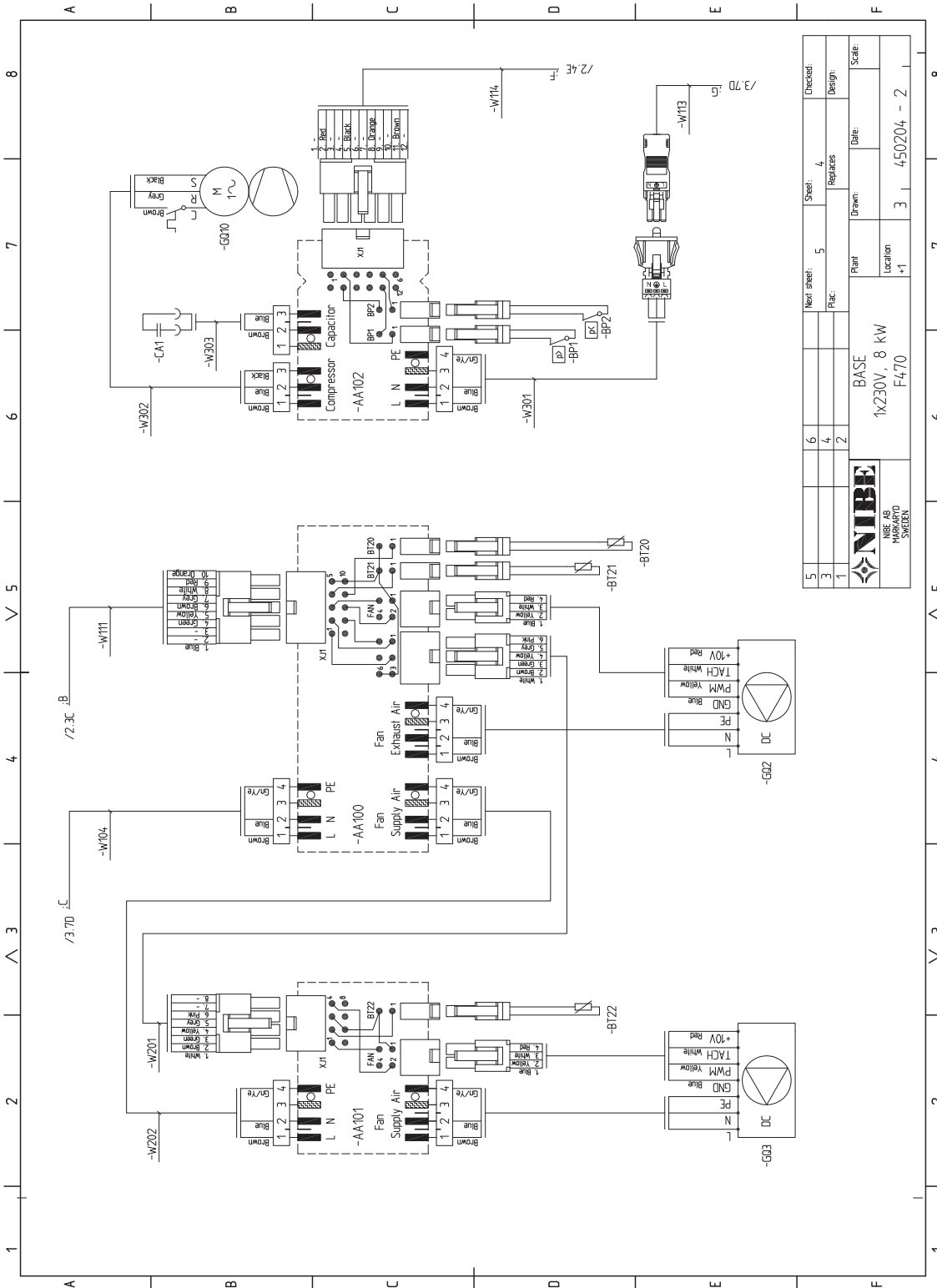

Sheet	Next sheet	Replaces	Checked
3	6	5	4
1	4	2	Design

Plant	Drawn	Date	Scale
+1	3	450204 - 2	

NIBE	
BASE 1x230V, 8 kW F4,70	
MUSKELÅS SWEDEN	

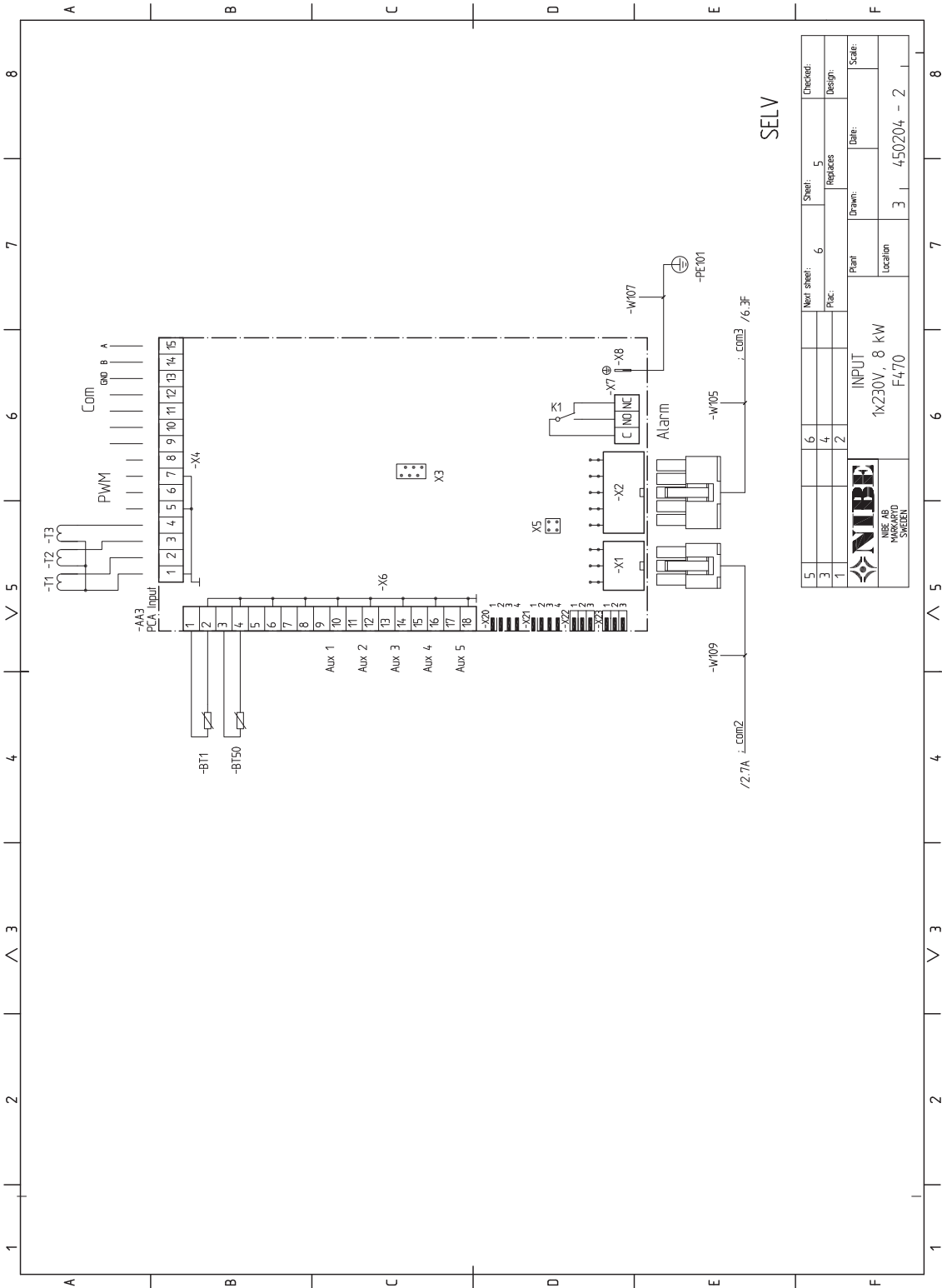

SELV

5	6	Next sheet:	5	Sheet:	5	Checked:
3	4	Fac:	6	Replaces	6	Design:
1	2	Drawn:	Plant	Location	Date:	Scale:
NIBE		INPUT		3		450204 - 2
MUSKARÖ		1x230V, 8 kW				
SWEDEN		F4,70				

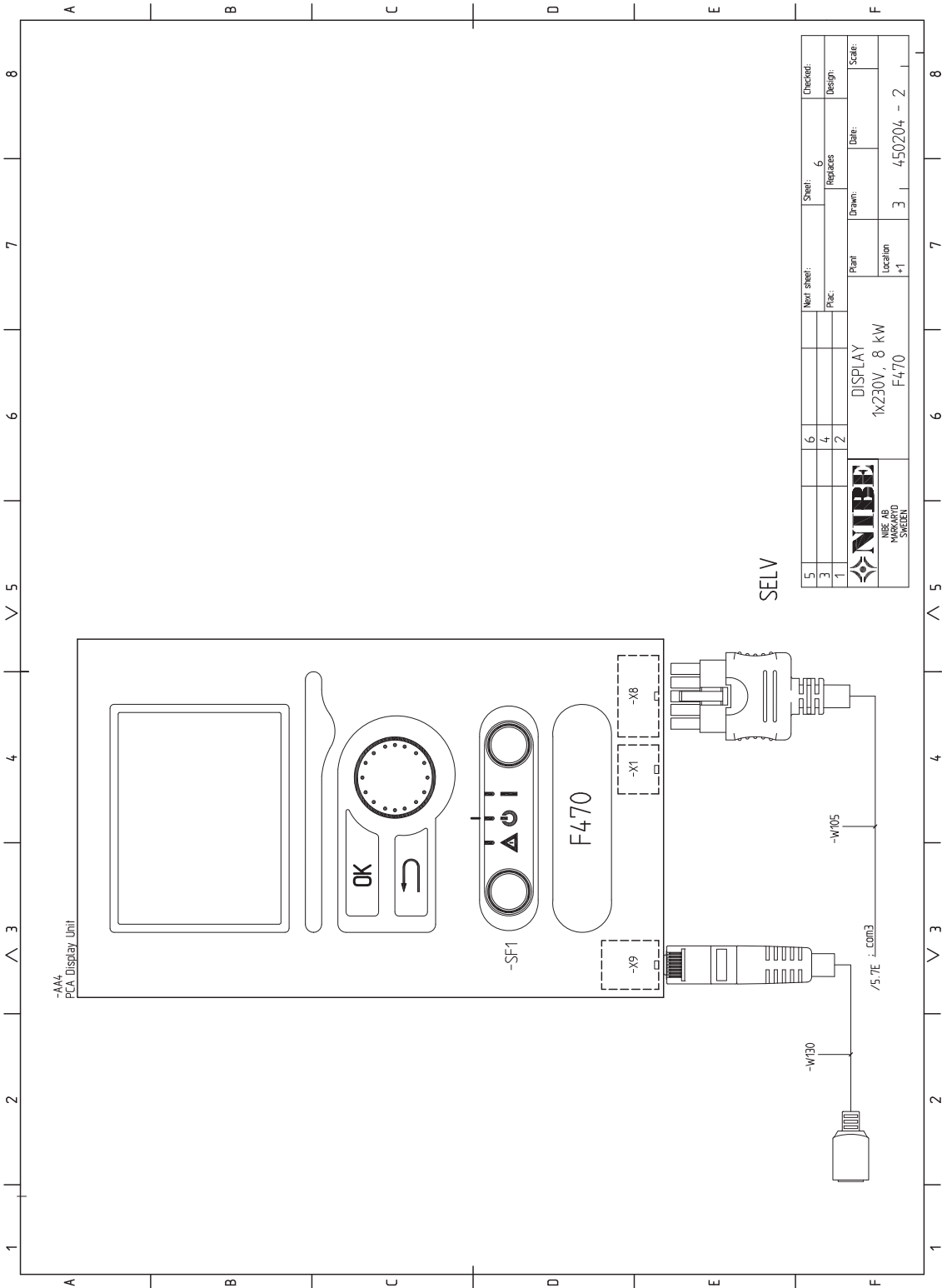

-AA4
PCA Display Unit

SELV

5					Checked:
3	6			Sheet: 6	Design:
1	4			Replaces:	
	2			Drawn:	Date:
				Plant	Scale:
				Location	
				+1	3 450204 - 2
 NIBE NIBE AB MÖRBYLÅN SWEDEN					
DISPLAY 1x230V, 8 kW F470					

13 Item register

Item register

A

Accessibility, electrical connection, 23
Accessories, 55
Alarm, 53
Assembly, 12

B

Back button, 38

C

Cable lock, 23
Cleaning the water heater, 49
Cold and hot water, 19
Commissioning and adjusting, 30
 Filling and venting, 30
 Preparations, 30
 Start guide, 31
 Start-up and inspection, 31
Connecting accessories, 29
Connecting cold and hot water, 19
Connecting the climate system, 19
Connections, 24
Control, 38, 42
 Control - Introduction, 38
 Control - Menus, 42
Control - Introduction, 38
 Display unit, 38
 Menu system, 39
Control knob, 38
Control - Menus, 42
 Menu 5 - SERVICE, 44
Country specific information, 10

D

Delivery and handling, 12
 Assembly, 12
 Installation area, 12
 Removing parts of the insulation, 13
 Removing the covers, 13
 Supplied components, 13
 Transport, 12
Dimensions and pipe connections, 18
Dimensions and setting-out coordinates, 56
Display, 38
Display unit, 38
 Back button, 38
 Control knob, 38
 Display, 38
 OK button, 38
 Status lamp, 38
 Switch, 38
Disturbances in comfort, 53
 Alarm, 53
 Manage alarm, 53
 Troubleshooting, 53
Draining the climate system, 49
Draining the hot water heater, 49

E

Electrical addition - maximum output, 26
Electrical circuit diagram, 61
 1x230V, 61
Electrical connections, 22
 Accessibility, electrical connection, 23
 Cable lock, 23
 Connecting accessories, 29
 Connections, 24
 Electrical addition - maximum output, 26
 External connection options, 27

 General, 22
 Load monitor, 27
 Miniature circuit-breaker, 22
 Optional connections, 27
 Outdoor sensor, 24
 Power connection, 24
 Removing the cover, base board, 23
 Removing the cover, immersion heater circuit board, 23
 Removing the hatch, input circuit board, 23
 Room sensor, 25
 Settings, 26
 Standby mode, 26
 Temperature limiter, 22
 Temperature limiter, compressor, 22
 Uplink, 27
Energy labelling, 59
 Data for energy efficiency of the package, 59
 Information sheet, 59
 Technical documentation, 60
Exhaust air duct, 21
External connection options, 27
 Possible selection for AUX inputs, 27
 Possible selections for AUX output, 29

F

Filling and venting, 30
 Filling the climate system, 30
 Filling the hot water heater, 30
 Venting the climate system, 30
Filling the climate system, 30
Filling the hot water heater, 30

H

Handling, 4
Heating medium side, 19
Helping the circulation pump to start, 50
Help menu, 31, 41

I

Important information, 4
 Country specific information, 10
 Recovery, 9
Inspection of the installation, 11
Installation alternative, 20
 Connecting hot water circulation, 20
 Extra hot water heaters, 20
 Two or more climate systems, 20
 Water heater with immersion heater, 20
Installation area, 12

M

Manage alarm, 53
Marking, 4
Menu 5 - SERVICE, 44
Menu system, 39
 Help menu, 31, 41
 Operation, 40
 Scroll through the windows, 41
 Selecting menu, 40
 Selecting options, 40
 Setting a value, 40
 Use the virtual keyboard, 41
Miniature circuit-breaker, 22

O

OK button, 38
Operation, 40
Optional connections, 27
Outdoor sensor, 24

P

- Pipe and ventilation connections, 16
 - Cold and hot water, 19
 - Connecting cold and hot water, 19
 - Connecting the climate system, 19
 - Dimensions and pipe connections, 18
 - Exhaust air duct, 21
 - General pipe connections, 16
 - Heating medium side, 19
 - Installation alternative, 20
 - Maximum boiler and radiator volumes, 17
 - Pipe dimensions, 18
 - Setting out dimensions, 18
 - Supply air battery, 20
 - Symbol key, 19
- Pipe dimensions, 18
- Possible selection for AUX inputs, 27
- Possible selections for AUX output, 29
- Power connection, 24
- Preparations, 30

R

- Remove parts of the insulation, 13
- Removing the cover, base board, 23
- Removing the cover, immersion heater circuit board, 23
- Removing the covers, 13
- Removing the hatch, input circuit board, 23
- Room sensor, 25

S

- Safety information
 - Handling, 4
 - Inspection of the installation, 11
 - Marking, 4
 - Safety precautions, 4
 - Serial number, 9
 - Symbols, 4
 - Symbols on F470, 4
 - Warranty information, 10
- Safety precautions, 4
 - Collection, 8
 - Decommissioning, 7
 - Filling, 7
 - Leak testing, 6
 - Marking, 8
 - Removal and draining, 7
 - Repairing sealed components, 6
 - When working in the refrigerant circuit, 9
 - Wiring, 6
- Scroll through the windows, 41
- Selecting menu, 40
- Selecting options, 40
- Serial number, 9
- Service, 48
 - Service actions, 49
- Service actions, 49
 - Cleaning the water heater, 49
 - Draining the climate system, 49
 - Draining the hot water heater, 49
 - Helping the circulation pump to start, 50
 - Standby mode, 49
 - Temperature sensor data, 50
 - USB service outlet, 51
- Setting a value, 40
- Setting out dimensions, 18
- Settings, 26
- Standby mode, 49
 - Power in emergency mode, 26
- Start guide, 31
- Start-up and inspection, 31
 - Commissioning without fans, 34

- Setting the pump speed, 34
- Setting the ventilation, 32
- Supply air battery, 33
- Status lamp, 38
- Supplied components, 13
- Supply air battery, 20
- Switch, 38
- Symbol key, 19
- Symbols, 4
- Symbols on F470, 4

T

- Technical data, 56
 - Dimensions and setting-out coordinates, 56
 - Electrical circuit diagram, 61
 - Technical Data, 57
- Technical Data, 57
- Temperature limiter, 22
 - Resetting, 22
- Temperature limiter, compressor, 22
 - Resetting, 22
- Temperature sensor data, 50
- The heat pump design, 14
 - Component locations, 14
 - List of components, 15
- Transport, 12
- Troubleshooting, 53

U

- Uplink, 27
- USB service outlet, 51
- Use the virtual keyboard, 41

V

- Venting the climate system, 30

W

- Warranty information, 10

Service Record

It is recommended that your heating system is serviced regularly and that the appropriate Service Interval Record is completed.

Service Provider

Before completing the appropriate Service Interval Record below, please ensure you have carried out the service as described in the manufacturer's instructions.

Always use the manufacturer's specified spare part when replacing controls.

Service 1

Date: _____

Engineer Name: _____

Company Name: _____

Telephone No. _____

Operative ID No. _____

Comments: _____

Signature: _____

Service 2

Date: _____

Engineer Name: _____

Company Name: _____

Telephone No. _____

Operative ID No. _____

Comments: _____

Signature: _____

Service 3

Date: _____

Engineer Name: _____

Company Name: _____

Telephone No. _____

Operative ID No. _____

Comments: _____

Signature: _____

Service 4

Date: _____

Engineer Name: _____

Company Name: _____

Telephone No. _____

Operative ID No. _____

Comments: _____

Signature: _____

Service 5

Date: _____

Engineer Name: _____

Company Name: _____

Telephone No. _____

Operative ID No. _____

Comments: _____

Signature: _____

Service 6

Date: _____

Engineer Name: _____

Company Name: _____

Telephone No. _____

Operative ID No. _____

Comments: _____

Signature: _____

Service 7

Date: _____

Engineer Name: _____

Company Name: _____

Telephone No. _____

Operative ID No. _____

Comments: _____

Signature: _____

Service 8

Date: _____

Engineer Name: _____

Company Name: _____

Telephone No. _____

Operative ID No. _____

Comments: _____

Signature: _____

Service 9

Date: _____

Engineer Name: _____

Company Name: _____

Telephone No. _____

Operative ID No. _____

Comments: _____

Signature: _____

Service 10

Date: _____

Engineer Name: _____

Company Name: _____

Telephone No. _____

Operative ID No. _____

Comments: _____

Signature: _____

NIBE Energy Systems Ltd
3C Broom Business Park
Bridge Way
Chesterfield S41 9QG
Phone 0845 095 1200
Fax 0845 095 1201
info@nibe.co.uk
www.nibe.co.uk



431683